



Installation and Maintenance Manual

## **CTC GS 600**

Modulating ground source heat pump

Model 606 / 608

400V 3N~/ 230V 1N~/ 230V 3N~



Important!

- Read carefully before use, keep for future reference.
- Translation of the original instructions.

# Table of contents

1.	Removing the cooling module .....	3	13.12	Current sensor connection (accessory).....	47
2.	Important! Information on air bleeding.....	4	13.13	Electrical diagram tank (A2), 3x400V /1.....	48
3.	Congratulations on your new product.....	5	13.14	Flow heater (E15), 3x400V /2.....	49
4.	Safety instructions.....	6	13.15	Terminal block (X2), 3x400V /3.....	50
5.	Important to remember! .....	7	13.16	Electrical diagram tank (A2), 1x230V /1.....	51
5.1	Transportation .....	7	13.17	Flow heater (E15), 1x230V /2.....	52
5.2	Positioning.....	7	13.18	Terminal block (X2), 1x230V /3.....	53
5.3	Recycling .....	7	13.19	Electrical diagram tank (A2), 3x230V /1.....	54
5.4	After commissioning .....	7	13.20	Flow heater (E15), 3x230V /2.....	55
6.	Installation.....	8	13.21	Terminal block (X2), 3x230V /3.....	56
6.1	Unpacking.....	8	13.22	HP cooling module schematic diagram 3x400V (A5).....	57
6.2	Control functions (std.) and with Expansion Card.....	9	13.23	HP cooling module schematic diagram 1x230V / 3x230V (A5).....	58
7.	Your home's heating installation .....	10	13.24	Expansion card (accessory) schematic diagram.....	59
8.	Technical data.....	14	13.25	Component list .....	61
8.1	Operating range CTC GS .....	16	13.26	Resistance values for sensor, cooling module .....	62
8.2	Measurements.....	17	13.27	Resistance values for sensor, other .....	63
9.	Design.....	18	14.	Installation Communication.....	64
10.	Parameter list GS 600.....	19	14.1	Install ethernet cable .....	65
11.	Pipe installation .....	20	14.2	Remote - Screen Mirroring .....	66
11.1	Schematic diagram.....	21	14.3	myUplink - App .....	66
12.	Connecting the brine system .....	35	15.	First start.....	67
12.1	Connections .....	35	16.	Operation and Maintenance .....	69
12.2	Brine system schematic diagram .....	38	17.	Detailed menu descriptions .....	70
13.	Electrical installation .....	41	17.1	Start menu.....	70
13.1	Sensor connection.....	42	17.2	Installation wizard.....	71
13.2	Checking connected sensors .....	43	17.3	Heating/Cooling .....	72
13.3	Pressure/level switch.....	43	17.4	DHW.....	76
13.4	Setting electrical output in backup power supply.....	43	17.5	Ventilation.....	76
13.5	Pump Diff thermostat function (G46) on/off.....	43	17.6	Schedule .....	77
13.6	Heating circuit 2 (alt. Passive cooling) .....	44	17.7	Operation data .....	79
13.7	Pool (accessory).....	45	17.8	Display .....	87
13.8	External heat source (EHS).....	45	17.9	Settings .....	89
13.9	CTC EcoVent (accessory).....	45	17.10	Define .....	106
13.10	CTC SmartControl (accessory).....	45	17.11	Service .....	119
13.11	Solar heat (accessory) .....	46	18.	Troubleshooting.....	123
			18.1	Information messages.....	125
			18.2	Alarm messages.....	126

## Software update



software.ctc.se

EN

For more information on updated functions and downloading the latest software, see the website "software.ctc.se".

# 1. Removing the cooling module



- Any work on the product's cooling system should be carried out by authorised personnel only.
- Close the safety switch before doing any work on the product.

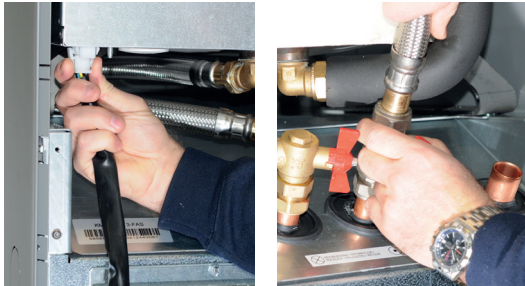

1. Disconnect the cooling module's power cable connector and hoses.



2. Attach the two carrying handles to the bottom edge of the cooling module.



3. Remove the cooling module fixing screws.



4. To pull out the cooling module, first lift the module slightly upwards using the carrying handles.



5. Lift the cooling module using the carrying handles and shoulder straps.

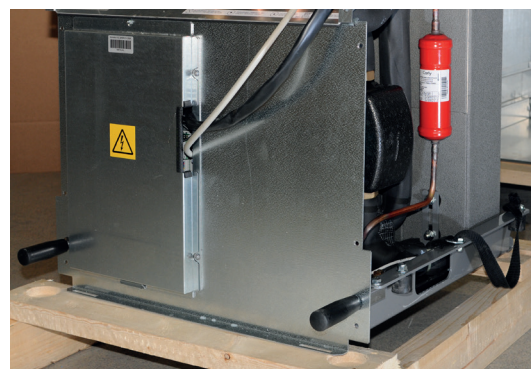

6. Lift the cooling module into the product using the carrying handles and shoulder straps. Remove the carrying handles and reconnect the power cable, hoses and screws.

## 2. Important! Information on air bleeding

**For the product to work as intended, the system must be fully bled.**

It is extremely important that a basic bleeding of the product is carried out systematically and carefully.

Bleeding devices must be fitted to the system's natural high points. A basic bleeding of the hot water tank can be carried out upon installation by releasing the safety valve, which must be fitted to the top of the product.

The water must be circulated during bleeding of the various subsystems: the radiator systems, heat pump system and hot water charging system (to run the pumps, 3-way valve etc. manually, go into the menu Installer/Service/Function test). Also move the 3-way valve during the bleeding process. A careful basic bleeding must be carried out before the system is put into operation and the heat pump is started.

### Tip:

Once basic bleeding is complete: increase the water pressure in the system temporarily to approx. 2 bar.

- Automatic bleeding valves are included in the package and supplied as standard for this product. They must be fitted to the top of the product as shown in the picture.
- Important! Bleed any air remaining in the radiators (elements) and other parts of the system after it has been in operation for a short time.

Small microbubbles gradually collect in the system's 'pockets', and it can take quite a long time before all the air is removed from the system. When the pressure is temporarily increased, any remaining air pockets are compressed and carried along more easily with the flow of water and can be released into the ventilation devices.

### Tip:

After the air is bled, there may be a drop in system pressure. Having the system pressure too low increases the risk of noise in the system and of air being 'sucked' in on the suction side of the pump. Keep an eye on the system pressure. Bear in mind that the system pressure will vary during the year due to changes in temperature in the heating circuit, which is completely normal.

If 'gushing' sounds can be heard from the product, this is a sign of remaining air.

A loss of heating functionality can also be a sign of remaining air.

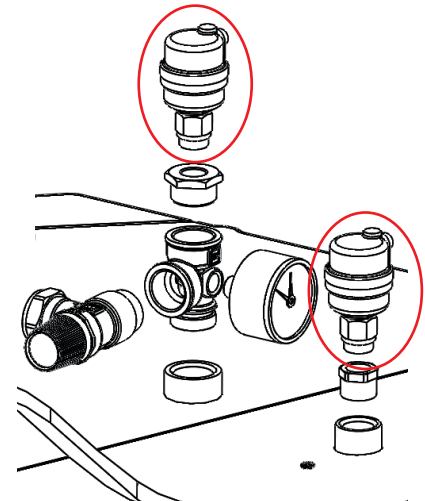

The automatic bleeder is equipped with shut off screws.



If these instructions are not followed during the installation, operation and maintenance of the system, CTC's liability under the applicable warranty terms is not binding.



Information in this type of box [i] is intended to help ensure that the product functions optimally.



Information in this type of box [!] is particularly important for correctly installing and using the product.

### 3. Congratulations on your new product



You have just purchased a CTC GS 600, with which we hope you will be very pleased. Read about how you can take care of your heat pump on the following pages.

Save this manual containing the installation and maintenance instructions. If looked after properly, you will be able to enjoy the use of your CTC GS for many years. This manual provides all the information you will need.

#### The complete heat pump

CTC GS is a complete heat pump able to meet both the heating and hot water needs of your home. It has a built-in, energy-efficient (A rated) circulation pump for connection to the ground/bedrock circuit, i.e. the cold side. This can be connected to either the left, right or back of the heat pump, whichever suits you best.

**!** NB: This installation manual contains information about technical data, operation, installation, etc. Local regulations or country-specific regulations must be considered.

#### CTC GS has a control system which:

- monitors all heat pump functions.
- allows for individual settings.
- Displays desired values, such as temperatures, operation times, energy consumption and fault signals.
- Facilitates the setting of values and troubleshooting in a simple and well-structured way.

The built-in heat exchanger provides copious amounts of hot water. CTC GS also has a summertime basement heating function and an underfloor heating blocking function, which maximises the temperature supplied to the floor circuits. Using the integrated night reduction function, you can set and change the temperature in the house during the day, from one day to the next.

Easily accessible electrical components and cooling modules, along with effective troubleshooting functions in the control program make CTC GS easy to service.

If you want to supplement your CTC GS with other sources of heating, you can do this easily. We have decided to call this option Energyflex. With Energyflex you can, for example:

- Charge your heating circuit with solar energy.
- Allow a water-jacketed stove to contribute heat.
- Connect a pool heat exchanger to heat up a swimming pool.

Eco design information can be downloaded from [www.ctc.se/ecodesign](http://www.ctc.se/ecodesign) where the energy labelling stickers can also be printed.

## 4. Safety instructions



Turn off the power with an omnipolar switch before doing any work on the product.



The product must be connected to protective earth.



The product is classified as IPX1. The product must not be rinsed with water.



When handling the product with a hoist ring or similar device, make sure that the lifting equipment, eyebolts and other parts are not damaged. Never stand under the hoisted product.



Never jeopardise safety by removing bolted covers, hoods or similar.



Any work on the product's cooling system should be carried out by authorised personnel only.



Installation and connection in the product must be carried out by a authorised electrician. All piping must be installed according to the applicable requirements.

Service of the product's electrical system must only be carried out by a qualified electrician in compliance with the specific requirements of the national standard for electrical safety.

Replacement of damaged supply cable, must be carried out by the manufacturer or qualified service engineer to avoid risk.



Safety valve check:  
-Safety valve for boiler/system to be checked regularly.



The product must not be started if it is not filled with water; instructions are in the "Pipe installation" section.



**WARNING:** Do not switch on the product if there is a possibility that the water in the heater is frozen.



This device can be used by children from the age of eight years and above and by people with reduced physical, sensory or mental ability or lack of experience or knowledge if they have been taught, either with supervision or with the instructions provided, how to use the device safely and understand the risks involved. Children should not play with the device. Cleaning and maintenance should not be carried out by children without supervision.



If these instructions are not followed when installing, operating and maintaining the system, CTC's commitment under the applicable warranty terms is not binding.

## 5. Important to remember!

Check the following points at the time of delivery and installation:

### 5.1 Transportation

Transport the unit to the installation site before removing the packaging. Handle the product in the following manner:

- Forklift.
- Lifting eye that has been fitted to the lifting sleeve on top of the product in the expansion connection.
- Lifting band around the pallet. **NB:** Can only be used with the packaging on. Remember that the product has a high centre of gravity and should be handled with caution.
- The product must be transported and stored in an upright position.

### 5.2 Positioning

- Remove the packaging and check before installation that the product has not been damaged in transit. Report any transport damage to the carrier.
- Place the product on a solid foundation, preferably made of concrete.  
**If the product needs to be placed on a soft carpet, base plates must be placed under the adjustable feet.**
- Avoid placing the heat pump in rooms where the walls are of lightweight design, as people in the adjoining room may be disturbed by the compressor and vibrations.

- Remember to leave a service area of at least 1 metre in front of the product.
- The product must not be placed below floor level either.

### 5.3 Recycling

- The packaging must be deposited at a recycling station or with the installation engineer for correct waste management.
- Obsolete products must be disposed of correctly and transported to a waste station or distributor/retailer offering this service. Disposal of the product as household waste is not permitted.
- It is very important that the product's refrigerant, compressor oil and electric/electronic components are disposed of correctly.

### 5.4 After commissioning

- The installation engineer advises the property owner on the design and servicing of the system.
- The installation engineer fills in a checklist and contact information – the customer and installation engineer sign the list, which the customer keeps.
- Register the product for warranty and insurance via the website <https://www.ctc-heating.com/customer-service#warranty-registration>

Fill in the information below. It may come in useful if anything should happen.

Product:	Serial number:
Installer:	Name:
Date:	Tel. no.:
Electrical installer:	Name:
Date:	Tel. no.:

No liability is accepted for any misprints. We reserve the right to make design changes.

## 6. Installation

This section is aimed at anyone responsible for one or more of the installations required to ensure that the product works the way the property owner wants.

Take your time going through functions and settings with the property owner and answer any questions. Both you and the heat pump benefit from a user who has completely understood how the system operates and should be maintained.

**!** The product must be transported and stored in an upright position.

### 6.1 Unpacking

Unpack the heat pump when it is placed next to its installation site. Check that the product has not been damaged in transit. Report any transport damage to the carrier. Also check that the delivery is complete according to the list below.

#### Delivery includes:

- Heat pump CTC GS
- Outdoor sensor
- Installation and maintenance manual
- Safety valve for heating circuit, 2.5 bar (3)
- Safety valve for cold side, 3 bar
- 2 x cable ties
- 2 x support sleeves
- Filter ball valve, magnetite for heating system return flow
- Dirt filter for cold tap water
- 2 x automatic bleeders (9)
- Pressure gauge (11)
- Manifold (8)
- Bushing 3/4" x 3/8" (10)
- Bushing 1/2" x 3/8" (12)

**!** As the cooling module is removable, there must be a free space of at least one metre in front of the product and it must not be placed below floor level either.

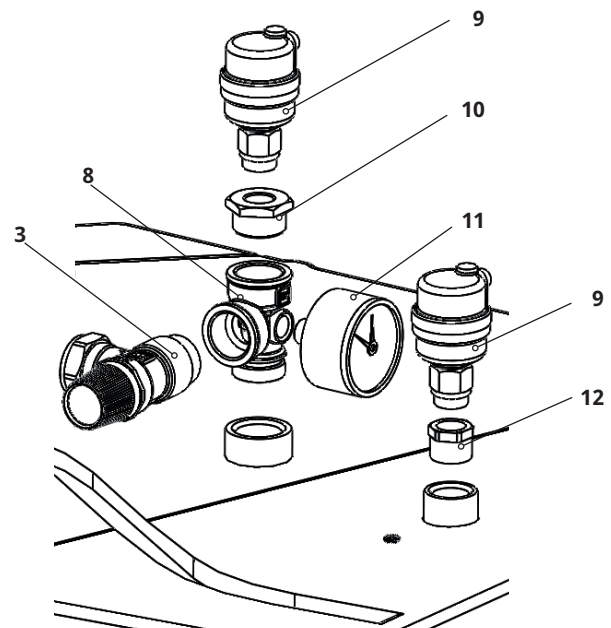



## 6.2 Control functions (std.) and with Expansion Card

The product is supplied from the factory with control functions according to "Basic functions" below.

Supplementing with the expansion card accessory (A3) adds solar control and its variants as well as bore hole recharging and various tanks. In addition, DHW circulation and pool control are also included.

### Basic functions

(built into the factory version)

- Heating circuit 1
- Heating circuit 2\*
- EHS tank\*
- Diff thermostat\*
- Passive cooling\*
- CTC SMS\*
- Remote control
- SmartGrid

### Functions with expansion card (A3)

(accessory)

- Solar control
- DHW circulation
- Pool

\* Requires accessories such as: Extra sensor, mixing valve group 2, etc.

# 7. Your home's heating installation

## The House Heating Curve

The heating curve is the central part of the product's control system. It is the heating curve which determines the compensated flow temperature requirements for your property dependent upon the outdoor temperatures. It is important that the heating curve is correctly adjusted, so that you achieve the best operation and economy possible.

One property requires a radiator temperature of 30 °C when the outdoor temperature is 0 °C, whilst a different property requires 40 °C. The difference between different properties is determined by the radiator surface area, the number of radiators and how well insulated the house is.

## Adjusting the heating curve

In the "Heating curve" menu under "Settings/Heating circuit", you can fine adjust the values of the heating curve for the primary flow temperature in relation to the outdoor temperature in the graph, as well as set the values for curve inclination and curve adjustment for the heating circuit.

**See section "Heating curve" in chapter "Settings/ Heating circuit" for detailed information.**

Ask your installer to help you set these values.

It is extremely important to set the heating curve and, in some cases, unfortunately, this process may take several weeks. The best way of doing this, upon the initial start-up, is to select operation without any room sensor. The system then operates using the outdoor temperature reading and the property's heating curve only.

**During the adjustment period it is important that:**

- the night reduction function is not selected.
- all thermostat valves on the radiators be fully opened. (This is to find the lowest curve for the most economical use of the heat pump).
- the outdoor temperature is not higher than +5 °C.
- the radiator system is operational and correctly adjusted between different circuits.

**i** For more information on how to set the heating curve, see section "Heating curve" in chapter "Settings / Heating circuit".

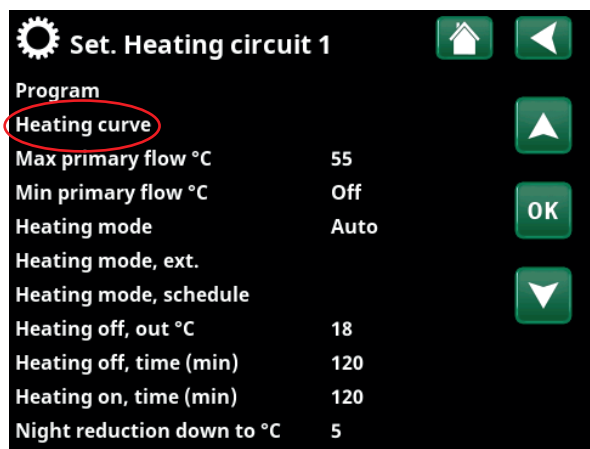

Part of the "Installer/Settings/Heating Circuit/Heating Circuit 1" menu.

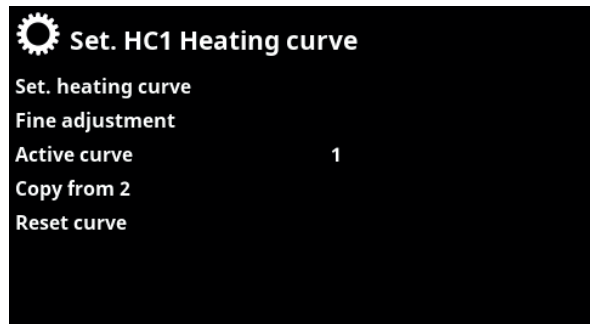

Menu: "Installer / Settings / Heating Circuit / Heating Circuit 1/Heating curve". Active curve: #1.

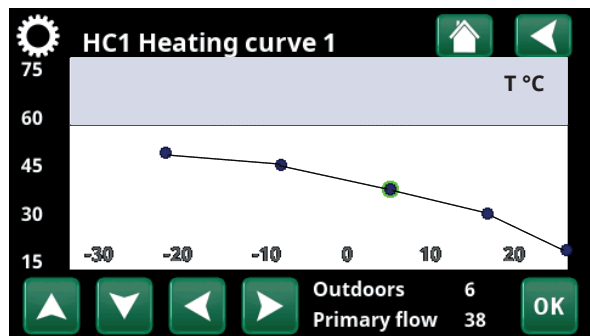

Menu: "Installer / Settings / Heating Circuit / Heating Circuit 1/Heating curve/Fine adjustment".

## Appropriate Default Values

During installation you can seldom achieve a precise setting for the heating curve instantly. In this case, the values given below may provide a good starting point. Radiators with small heat-emission surfaces require a higher primary flow temperature. You can adjust the gradient (heating curve gradient) for your heating system under the "Installer / Settings / Radiator system" menu. Recommended values are:

Floor heating only:	Inclination 35
Low temperature system: (well insulated houses)	Inclination 40
Normal temperature system: (factory setting)	Inclination 50
High temperature system: (older houses, small radiators, poorly insulated)	Inclination 60

## Adjusting the heating curve

The method described below can be used to adjust the heating curve correctly.

### Adjustment if it is too cold indoors:

- If the outdoor temperature is **lower** than 0 degrees:  
Increase the Inclination value by a couple of degrees.  
Wait 24 hours to see if any further adjustment is required.
- If the outdoor temperature is **higher** than 0 degrees:  
Increase the Adjustment value by a couple of degrees. Wait 24 hours to see if any further adjustment is required.

### Adjustment if it is too warm indoors:

- If the outdoor temperature is **lower** than 0 degrees:  
Decrease the Inclination value by a couple of degrees.  
Wait 24 hours to see if any further adjustment is required.
- If the outdoor temperature is **higher** than 0 degrees:  
Decrease the Adjustment value by a couple of degrees.  
Wait 24 hours to see if any further adjustment is required.



The set heating curve always takes priority. The room sensor can only increase or decrease the heat beyond the set heating curve to a certain extent. Where operating without a room sensor, the selected heating curve determines the flow temperature supplied to the radiators.

## Examples of Heating Curves

You can see in the diagram below how the heating curve changes with different Inclination settings. The gradient of the curve shows the temperatures that the radiators require at different outdoor temperatures.

### Curve Inclination

The inclination value which is set is the primary flow temperature when the outside temperature is  $-15^{\circ}\text{C}$ .

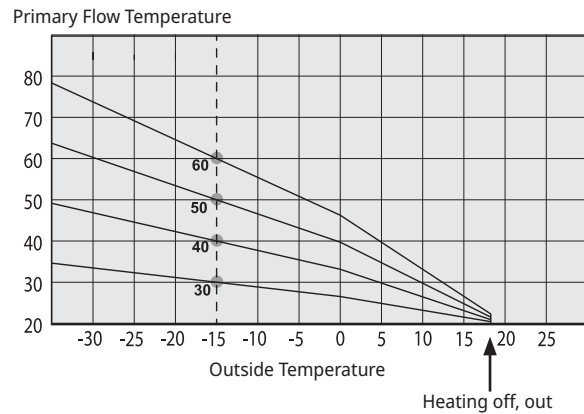

### Adjustment

The curve can be parallel displaced (adjusted) by the desired number of degrees to adapt to different systems/ houses.

Inclination  $50^{\circ}\text{C}$   
Adjustment  $+5^{\circ}\text{C}$

Inclination  $50^{\circ}\text{C}$   
Adjustment  $0^{\circ}\text{C}$

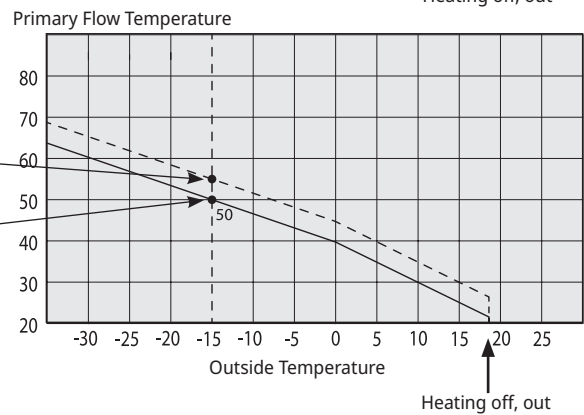

### An example

Inclination  $60^{\circ}\text{C}$   
Adjustment  $0^{\circ}\text{C}$

In this example, the maximum outgoing primary flow temperature is set at  $55^{\circ}\text{C}$ . The minimum permitted primary flow temperature is  $27^{\circ}\text{C}$  (e.g. summer-time basement heating or the floor circuits in a bathroom).

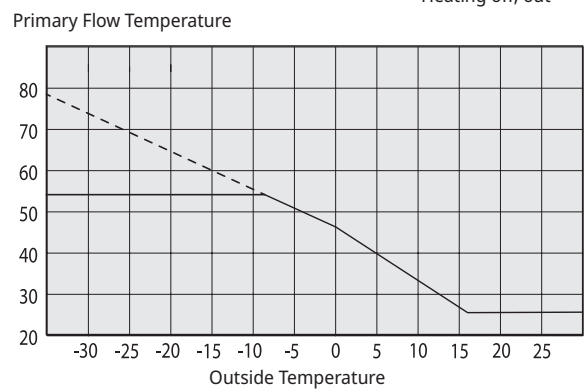

If the values set are too low, this may mean that the desired room temperature is not being reached. You then need to adjust the heating curve, as necessary, following the method shown above.

### Summer season

All properties have internal heat gains (lamps, oven, body heat, etc.), which means that the heating can be switched off when the outdoor temperature is lower than the desired room temperature. The better insulated the house is, the earlier the heating from the heat pump can be switched off.

The example shows the product set at the default value of 18°C. This value, "**Heating off, outside**", can be changed in the "Installer/Settings/Heat circuit" menu.

In systems with a radiator pump, the radiator pump stops when the heat is switched off. The heating starts up automatically when it is required again.

See chapter "Settings/Heating circuit" for information on setting the heating mode.

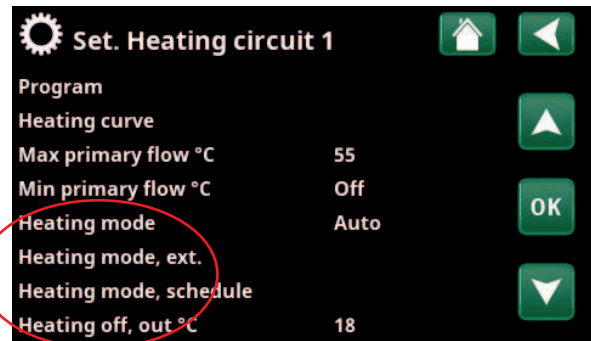
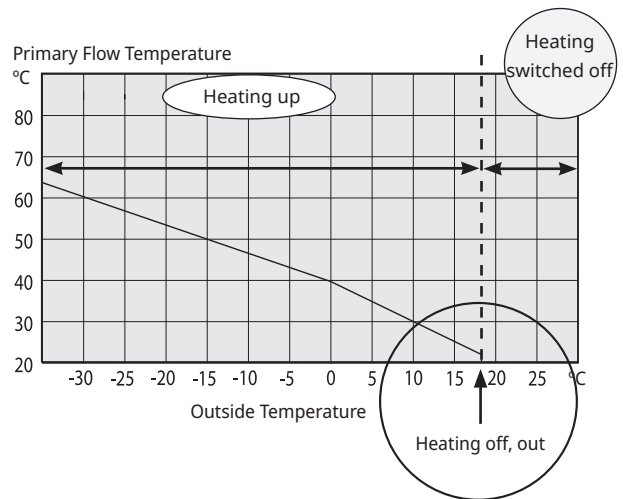

Part of the "Installer/Settings/Heating Circuit/Heating Circuit 1" menu.

## 8. Technical data

Electrical data		GS 606			GS 608		
CTC No.		589310001	589311001	589312001	589310002	589311002	589312002
Rated electrical data		3x400V	1x230V	3x230V	3x400V	1x230V	3x230V
Rated power cooling module	kW	2.4	2.75	2.75	3.6	3.45	3.45
Rated power input	kW	11.5	8.25	9.75	12.7	8.95	10.45
Rated current cooling module	A	3.5	10.9	10.9	5.1	15.3	15.3
Rated current	A	17.1	38	18.09	18.6	42.5	34
Max immersion heater output @ fuse size <sup>1)</sup>	kW	2.1/2.1/6.9/9.0/9.0	0.3/0.9/3.2/3.2/5.5/5.5	3.5/4.7/5.9/7.0/7.0/7.0	0.9/2.1/4.9/7.8/9.0	0.0/0.0/0.9/2.3/5.5/5.5	0.0/3.5/4.7/5.9/7.0/7.0
Group fuse	A	20	50	32	20	50	35
Max. start current	A	16.6	18.09	18.09	17.7	21.4	21.4
Output range immersion heater (min-max)	kW	0.3-9	0.3-5.5	1.2-7	0.3-9	0.3-5.5	1.2-7
Ingress Protection (IP)		IP X1					
HP Keymark Cert.		012-C700089	012-C700089	-	012-C700090	012-C700090	-

<sup>1)</sup> Fuse size GS 606/608 3x400V: 10 A / 13 A / 16 A / 20 A / 25 A.

Fuse size GS 606/608 1x230V / 3x230V: 20 A / 25 A / 32 A / 35 A / 50 A / 63 A.

Operational data for heat pump			GS 606	GS 608
Heating capacity <sup>2)</sup>	@B0/35   B5/W35   B10/W35	kW	6.04 I 6.8 I 7.54	8.29 I 9.52 I 10.9
Power input <sup>2)</sup>	@B0/35   B5/W35   B10/W35	kW	1.34 I 1.33 I 1.41	1.74 I 1.76 I 1.83
COP <sup>2)</sup>	@B0/35   B5/W35   B10/W35	-	4.52 I 5.11 I 5.36	4.77 I 5.4 I 5.93

<sup>2)</sup> EN14511

Heating system		GS 606	GS 608
Water volume (V)	l	229	
Max. operating pressure boiler (PS)	bar	3.0	
Max. temperature boiler (TS)	°C	100	
Max. operating temperature condenser	°C	65	
Flow qw minimum A7 or B0/W35, Δt = 15K	l/s	0.10	0.11
Flow qw nominal A7 or B0/W35, Δt = 5K	l/s	0.29	0.41
Max ext available pressure head, nom flow	kPa	66	56
Pressure drop		See diagram in chapter "Pipe installation".	

<b>Brine system</b>		<b>GS 606</b>	<b>GS 608</b>
Water volume (V)	l	3.57	4.1
Brine system min/max temp (TS)	°C	-5 / +20	
Brine system min/max pressure (PS)	bar	0.2 / 3.0	
Flow qc minimum B0/W35, Δt = 6K	l/s	0.21	0.23
Flow qc nominal B0/W35, Δt = 3K	l/s	0.33	0.46
Pump capacity		See diagram in chapter „Pipe installation“.	
Ext available pump pressure nominal flow	kPa	48	41

<b>DHW system</b>		<b>GS</b>	
Water volume (V)	l	1.7	
Max operating pressure (PS)	bar	10	
Max operating temperature (TS)	°C	100	
<b>DHW capacity (EN16147) Economic/Normal/Comfort</b>		<b>GS 606</b>	<b>GS 608</b>
DHW capacity	l	210 / 239 / 304	210 / 241 / 304
COP/ (Tapping cycle)		2.19 / 2.49 / 2.32	2.58 / 2.78 / 2.57

<b>Pipe connections</b>		<b>GS</b>
Brine circuit, ext. diam. Cu piping (flexible hose)	mm	28
Heating medium, ext. diam. Cu piping	mm	22
Hot water supply, ext. diam.	mm	22
Cold water supply, ext. diam.	mm	22

<b>Other data</b>		<b>GS 606</b>	<b>GS 608</b>
Refrigerant quantity (R407C, fluorinated greenhouse gases GWP 1774)	kg	1.9	
CO2 equivalent	ton	3.371	
Interrupt value switch HT	bar	31	
Weight with / without packaging	kg	285 / 256 (283 / 254: 3x400V)	283 / 254 (281 / 252: 3x400V)
Dimensions (Depth x Width x Height)	mm	673 x 596 x 1876	673 x 596 x 1882
Required ceiling height	mm	1940	
Sound power (LWA) acc. to EN 12102 @B0, W35/55	dB(A)	41 / 41	39 / 39
Noise pressure (LPA) 1m B0/W35 (EN ISO 11203)	dB(A)	36	34

No annual leakage control of the refrigerant is required.

# 8.1 Operating range CTC GS

Operating range is based on normal operating conditions and may therefore be different in different installations.

( $t_{ci}$  = temperature brine in)

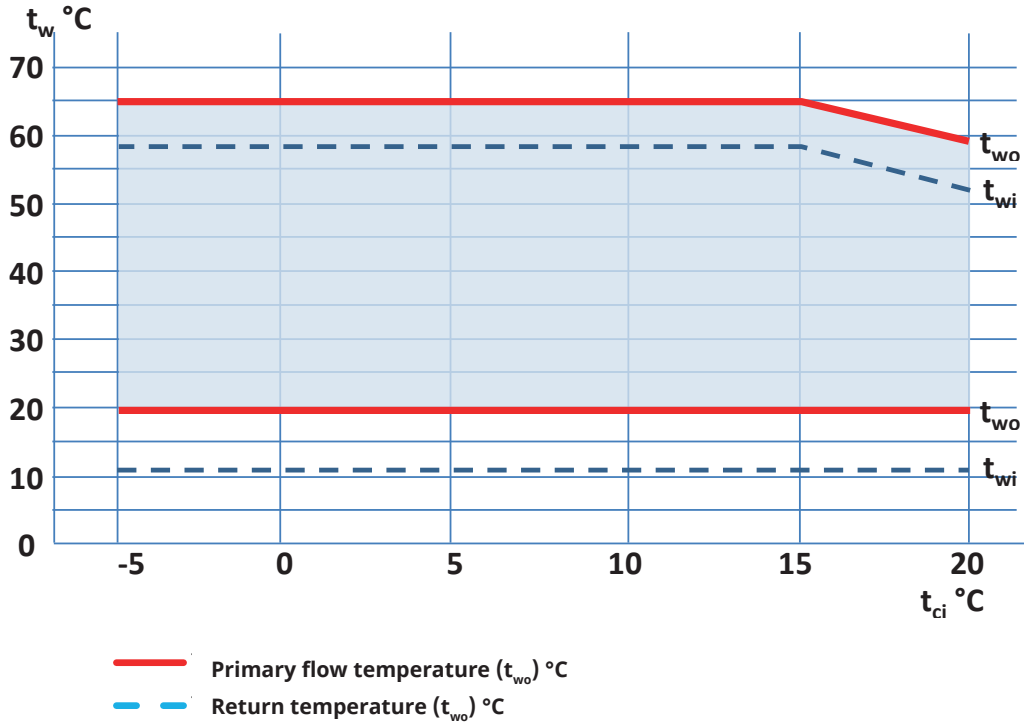



## 8.2 Measurements

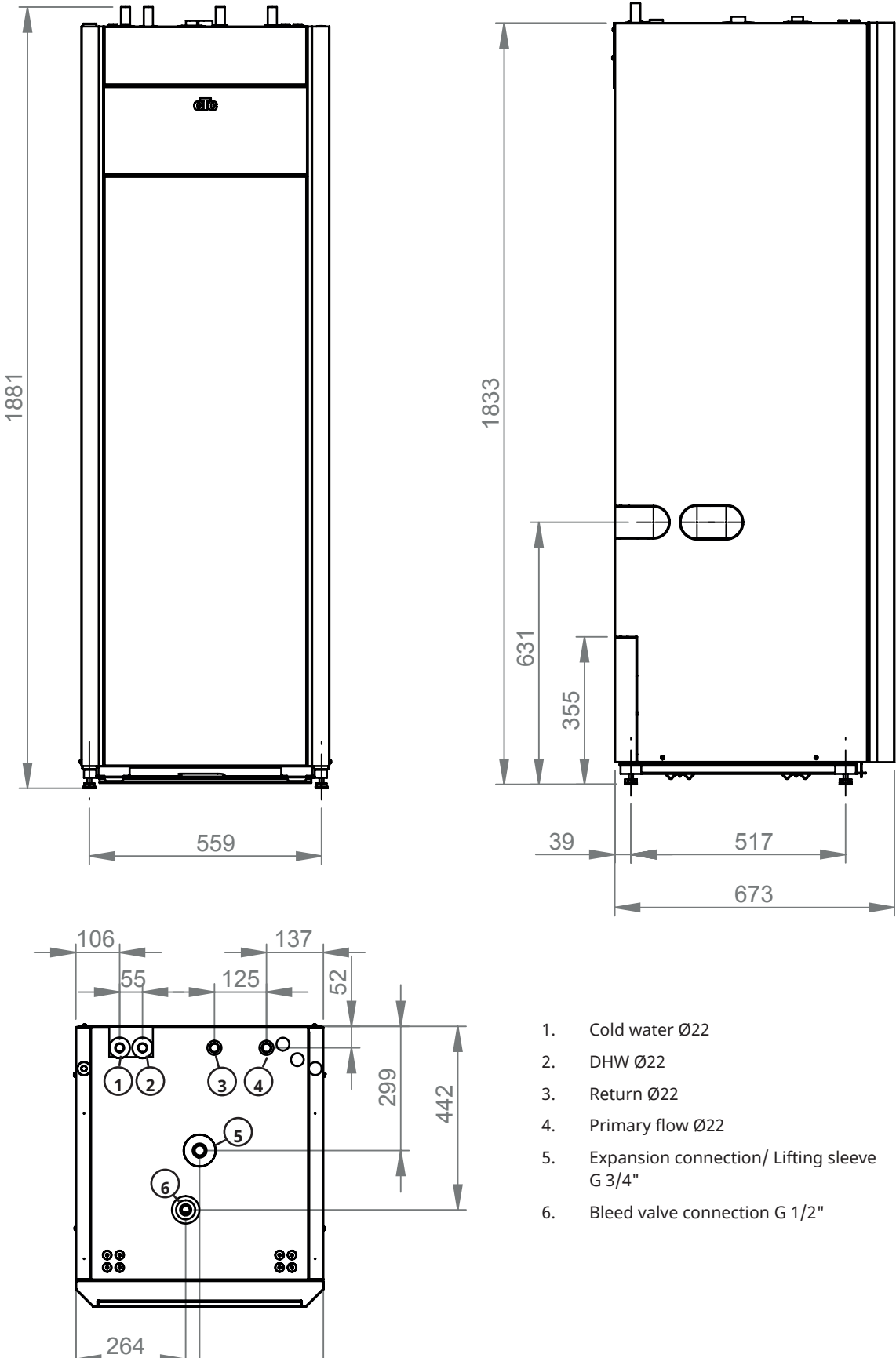

1. Cold water Ø22
2. DHW Ø22
3. Return Ø22
4. Primary flow Ø22
5. Expansion connection/ Lifting sleeve G 3/4"
6. Bleed valve connection G 1/2"

# 9. Design

The picture below shows the fundamental construction of the heat pump.

The energy in the bore hole (bedrock) or ground is drawn up by the cooling system. The compressor then increases the temperature to a usable level. Afterwards it releases the energy for the heating circuit and DHW.

**DHW connections**  
The property's DHW connections are connected here.

**DHW heat exchanger**  
The heat pump is equipped with a stainless steel heat exchanger.  
Direct heating of hot water minimises the risk of legionella bacteria.

**Circulation pump, DHW**  
Charge pump (G5) for DHW out temp.

**Junction box (A2)**

**Max. thermostat (F10)**

**Circuit breakers (F2)**

**Circuit breakers (F1)**

**Junction box (A5) Module**

**Charge pump (G11)**  
Pump for the hot side (concealed, placed behind the electrical connection box).

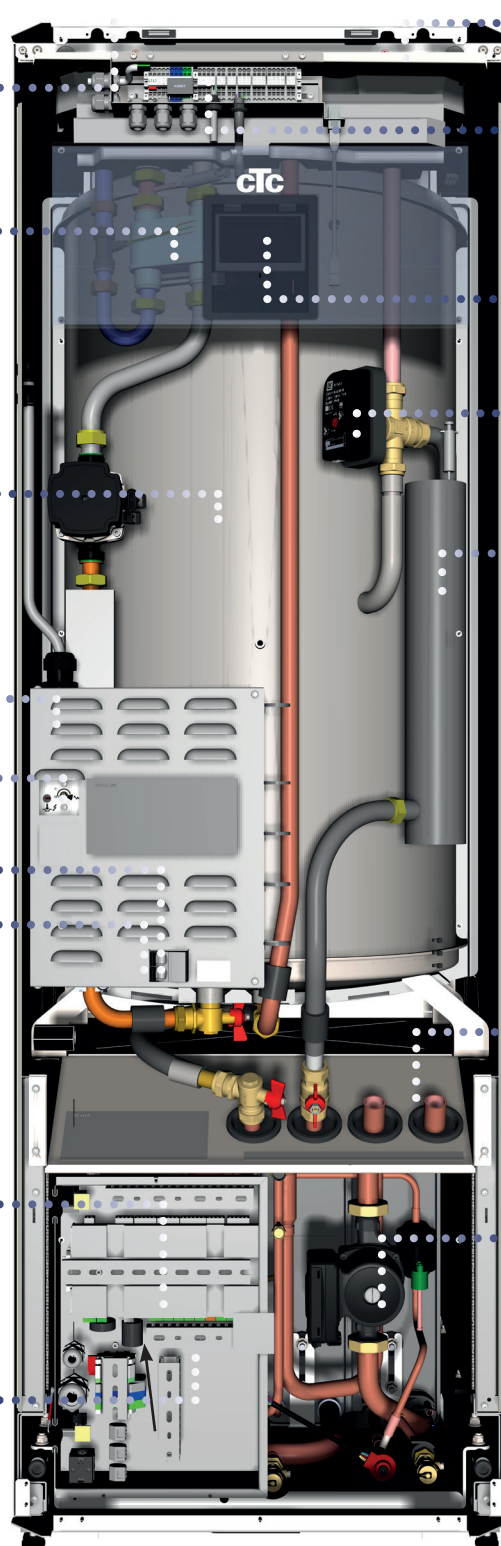

**Radiator connections**  
The property's heating system is connected here.

**Terminal block for sensors**  
The sensor terminal block is wired internally. Outdoor sensors, room sensors and other sensors are connected easily here.

**Display (A1)**

**3-way valve**  
Flow conditioner.

**Flow heater**  
There is an immersion heater for additional heating here.

**Brine connections**  
The brine is connected to the collector here.

**Brine pump (G20)**

## 10. Parameter list GS 600

	Factory setting
<b>Heating circuit</b>	
Program Economy	-
Room temp change °C	-2.0
Off delay, min	30
Program Comfort	-
Room temp change °C	2.0
Off delay, min	30
Max primary flow °C	60
Min primary flow °C	Off
Heating mode	Auto
Heating off, out °C	18
Heating off, time (min)	120
Heating on, time (min)	120
Night reduction down to °C	5
Room temp. reduced, Night red °C	-2
Room temp. reduced, Holiday °C	-2
Prim. flow reduced, Night red °C	-3
Prim. flow reduced, Holiday °C	-3
Alarm room temp °C	5
SmartGrid Low Price °C	Off
SmartGrid Overcapacity °C	Off
SmartGrid Blocking	Off
Max time heating (min)	20
Charge pump %	60*
Drying period mode	Off
Drying period temp °C	25
Drying period mode	Off
<b>Heat pump</b>	
Compressor	Blocked
Brine pump	Auto
Compressor stop at brine °C	-5
Tariff HP	No
SmartGrid Block. HP	No
Start at degree minute	-60
Max RPS	100
Passive cooling brine pump On	On

	Factory setting
<b>Immersion heater</b>	
Max el. heater kW	5.8*
Max el. heater DHW kW	0.0*
Start at degree minute	-500
Diff step, degree minute	-50
Main fuse A	20
Conv. factor current sensor	1
Tariff EL	No
SmartGrid Block. immersion	No
<b>DHW</b>	
DHW program	Economy Normal Comfort
Start/stop diff. upper °C	5
Max time DHW (min)	30
Charge pump %	90
SmartGrid Blocking °C	Off
SmartGrid Low Price °C	Off
SmartGrid Overcapacity °C	Off
SmartGrid Overcapacity Block. HP	No
Run time DHW circ. (min)	4
Time DHW circ. (min)	15
Time ExtraDHW Remote Contr.	0.0
HC2 Mixing valve close	120
<b>External heat source (EHS)</b>	
Charge start °C	70
Stop diff (°C)	5
SmartGrid block cap.	No
<b>Diff thermostat function</b>	
Charge start diff temp °C	7
Charge stop diff temp °C	3
Charge temperature °C	60
<b>Cooling</b>	
Room temp. cooling °C	25.0
SmartGrid Low Price °C	Off
SmartGrid Overcapacity °C	Off
Ext. block cooling	Off
Block cooling schedule	
<b>Communication</b>	
<b>Ethernet</b>	-
<b>BMS</b>	-
<b>El. prices</b>	
Price control	No

\*The value varies depending on the heat pump model, see chapter "Electrical installation".

# 11. Pipe installation

The installation must be carried out in accordance with the applicable standards. The product must be connected to an expansion vessel in an open or closed system. **Do not forget to flush the heating circuit clean before connecting.** Apply all the installation settings based on the description in the section entitled "First start".

In order to adjust the pressure in the expansion vessel and check the pipe fittings before the first start, the front needs to be dismantled.

1. Remove magnetic strip.
2. Loosen the two screws on top.
3. Fold out and set the front to the side.
4. Bear in mind that the cable to the display on the front is sensitive to damage.

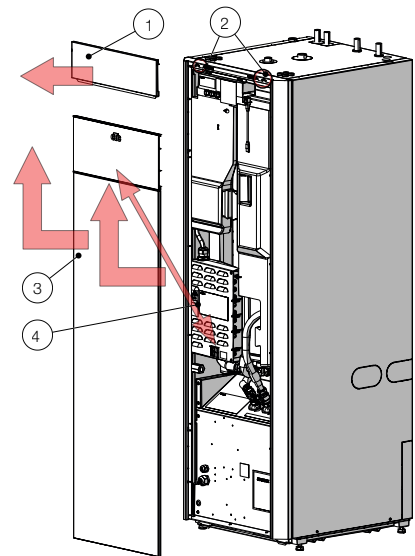

Dirt filter for tap water

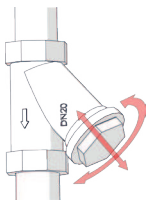

Safety valve

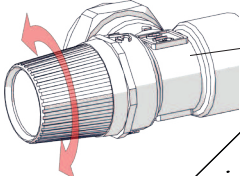

Automatic bleeder

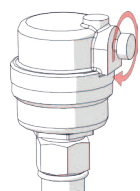

Solenoid filter ball valve

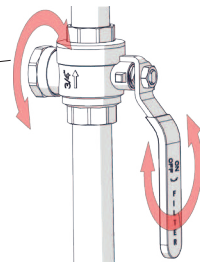

Manometer

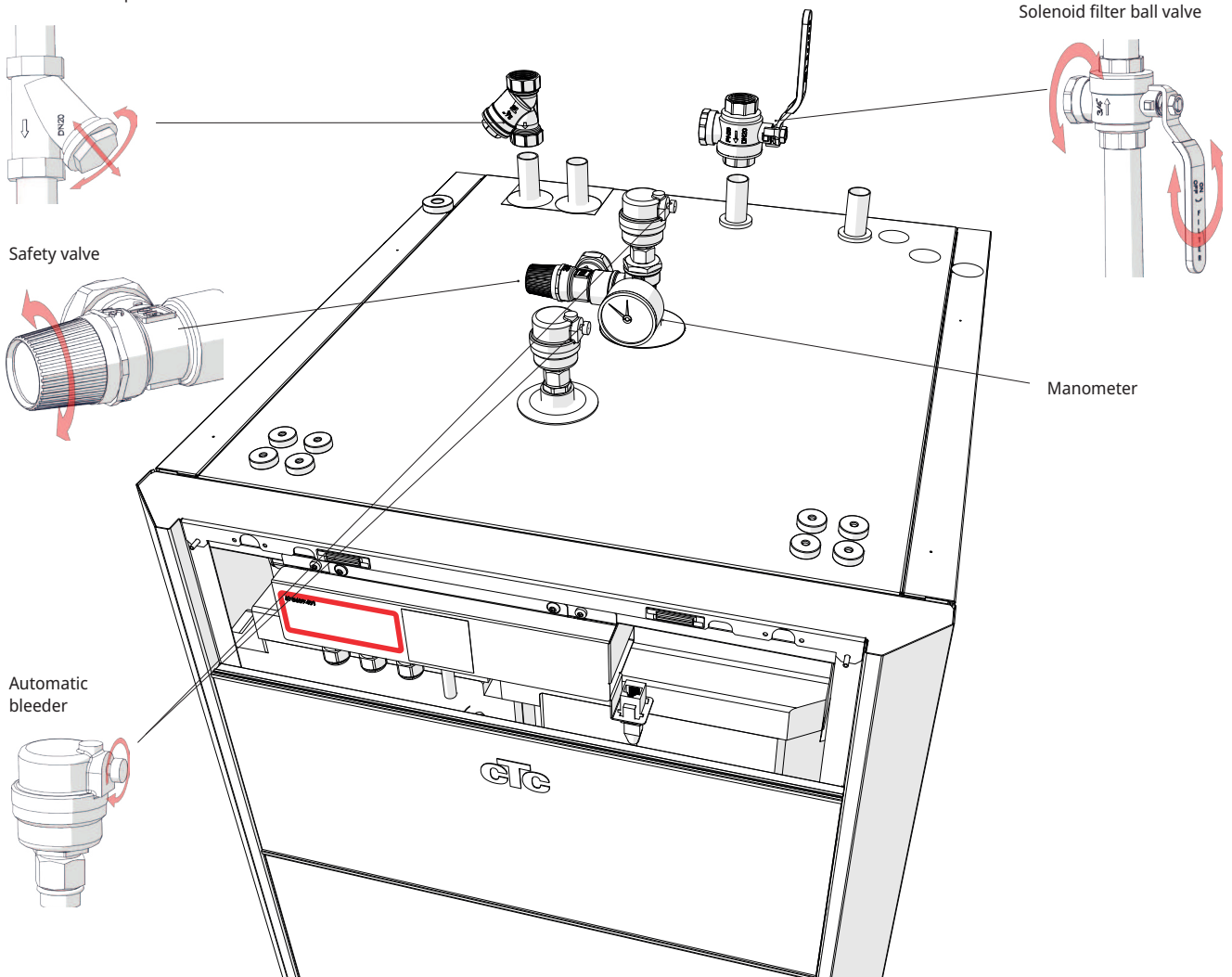

## 11.1 Schematic diagram

This shows the main connection between the heat pump and the property's heating and water supply system. Different installations and systems may look different, e.g. a one or two-pipe system, which means that the finished installation may be different. To find out about connecting the cold side, see the section entitled "Connecting the brine system".

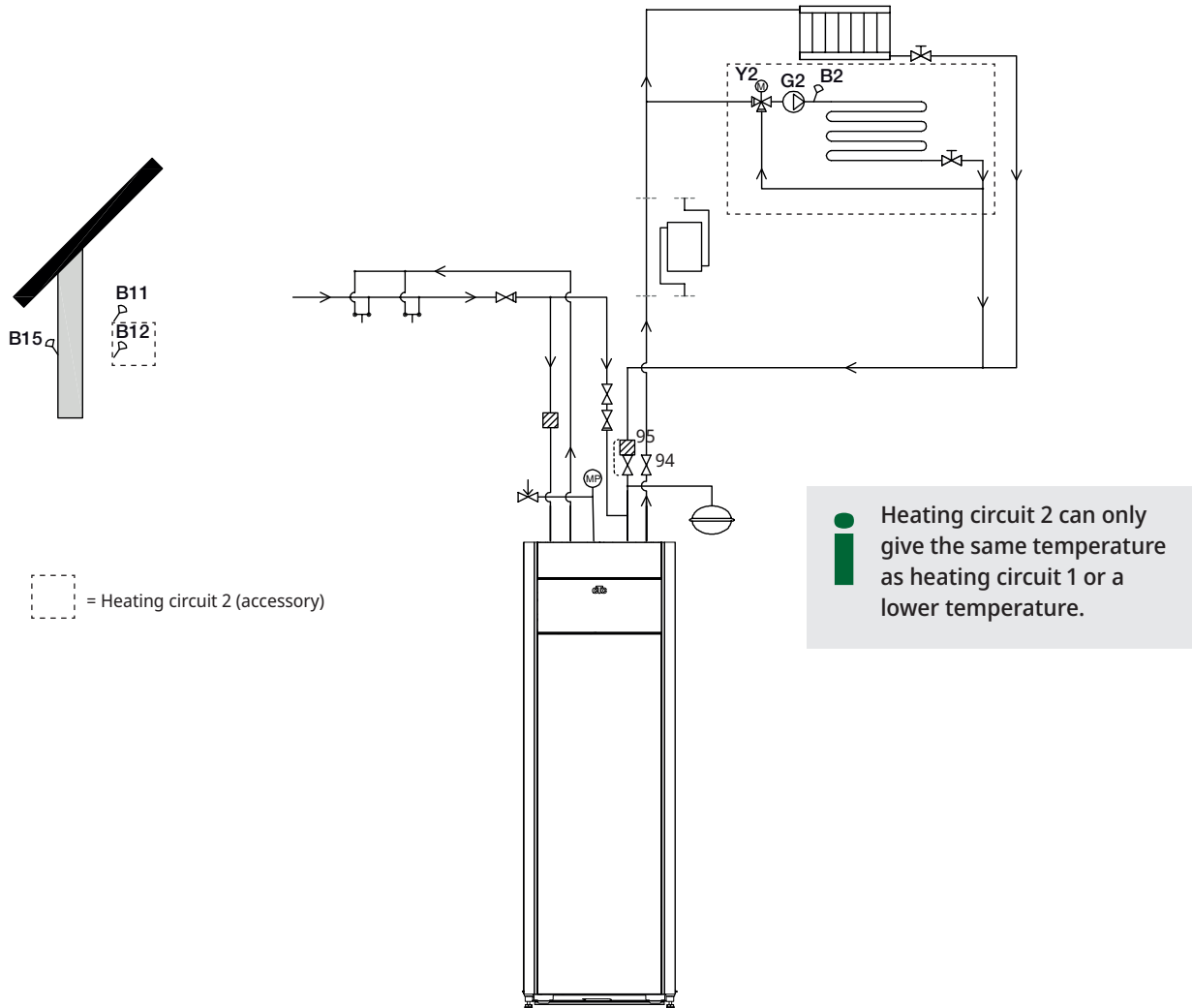

### 11.1.1 Filling valve, heating circuit

Fit a filling valve between the cold water connection and the heating circuit's return flow.

### 11.1.2 Non return valve

Fit the non-return valve to the incoming cold water connection.

### 11.1.3 Shut-off valves

It is important to fit a shut-off valve (94) to the primary flow.

The supplied filter ball valve (95) must be fitted to the heating circuit's return flow.

### 11.1.4 Safety valve

The heat pump's safety valve (2.5 bar) for the heating circuit must be fitted in accordance with applicable regulations. Connect the waste pipe to the waste system directly to the floor drain or, if the distance is more than two metres, to a funnel. The waste pipe must slope towards the waste system, be installed frost-free and left open to the atmosphere/without pressure.

### 11.1.5 Manometer – system pressure

Fit a manometer to the expansion pipe or the heating circuit's return line.

### 11.1.6 Connection of expansion tank (accessory)

The heat pump is best connected to a closed expansion vessel. The heat pump is ready to be fitted to an 18 l closed expansion vessel, positioned on top of the product. The expansion tank with the required hose and connectors is available as an accessory.

If you use an open system, the distance between the expansion vessel and the highest placed radiator must not be below 2.5 m in order to avoid introducing oxygen into the system.

If the heat pump is connected with another heat source, e.g. an existing boiler, the installations must have separate expansion vessels.

**!** NB: It is important to fit shut-off valves to both the primary and return flows.

**!** NB: The waste pipe must be fitted to the waste system.

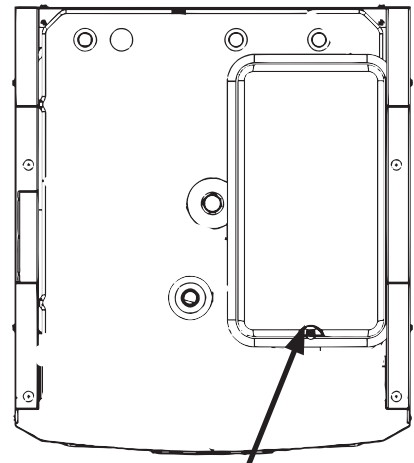

Position of expansion tank.

### 11.1.7 Expansion tank pre-pressure

The pre-pressure in the expansion tank is calculated according to the height (H) between the highest-positioned radiator and the expansion tank. The pre-pressure must be checked/set before the system is filled with water. The system pressure must be set 0.3 bar higher than the pre-pressure in the expansion tank. For example, a pre-pressure of 1.0 bar (5 mvp) means a maximum permitted height difference of 10 m.

Maximum height (H) (m)	Pre-pressure (bar)	Maximum volume in the heating circuit (excluding product) (L)
5	0.5	179
10	1.0	78

The table assumes installation with the expansion tank included in the CTC Installation Kit GSi/GS accessory.

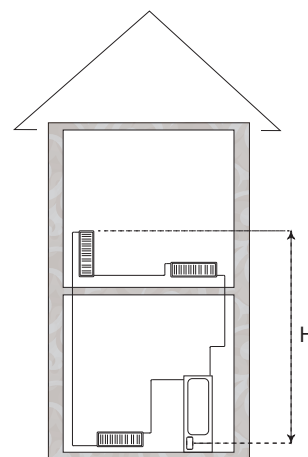

- !** The expansion vessel is pre-pressurised to approx. 1 bar, and therefore needs to be adjusted to a suitable pre-pressure for the building. This must be done before the system is filled with water.
- If an open expansion vessel is used, the distance between the expansion vessel and the highest radiator should not be less than 2.5 meters to avoid the system being oxygenated. If a heat pump is connected with another heat source, e.g. an existing boiler, the installations must have separate expansion vessels.

### 11.1.8 Pressure differential diagram - hot side

CTC GS 606 / 608

$\Delta p$  kPa

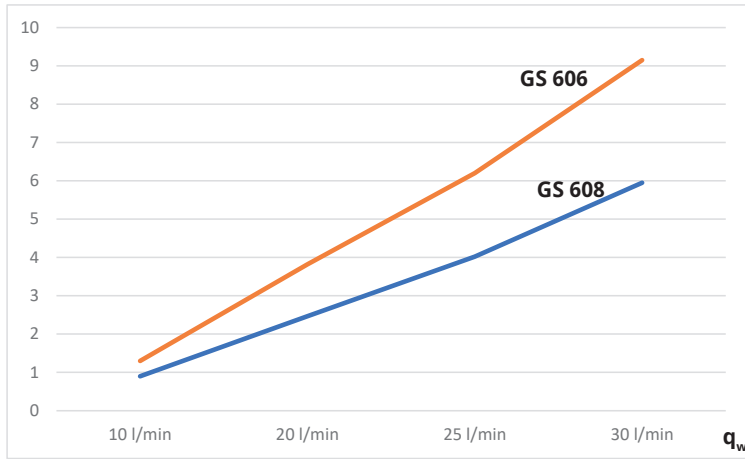

### 11.1.9 Heat medium pump (G11)

GS 608 / GS 612

25/7-130 PWM

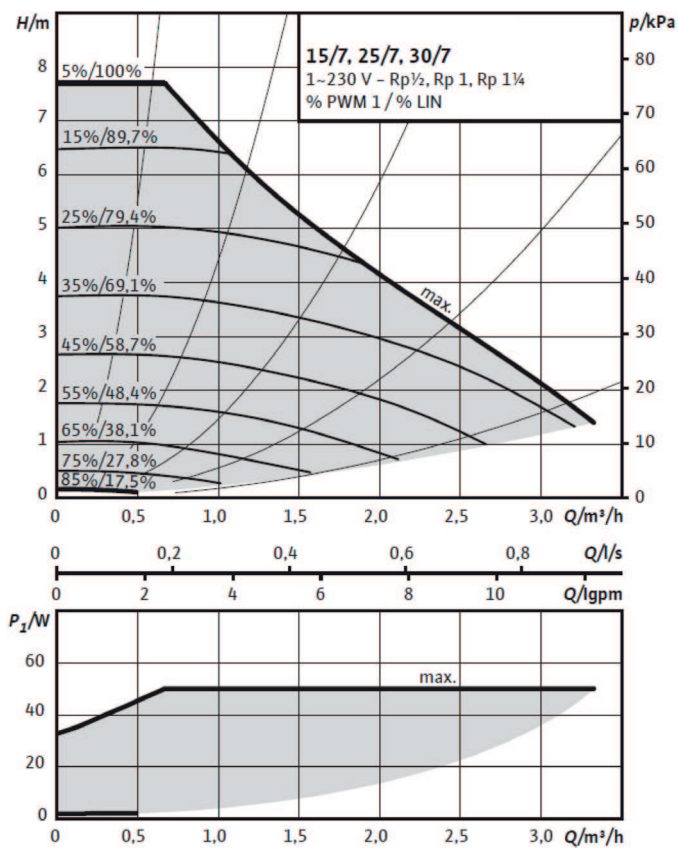



### 11.1.10 Electric shut-off valve Y47

If you have two heating circuits and wish to have background heating in heating circuit 2 and the heat off during the summer in heating circuit 1, you can use an electric shut-off valve (Y47). Terminal block A13 is powered during the heating season and not powered in the summer.

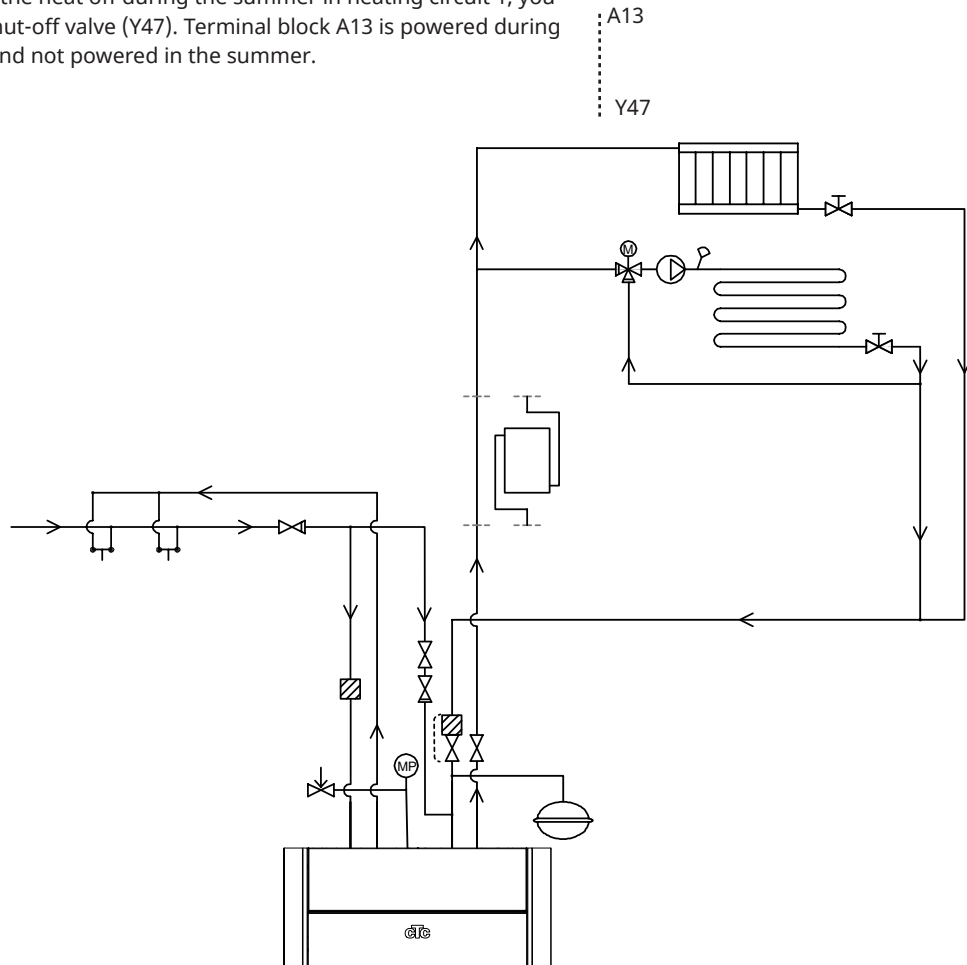

### 11.1.11 DHW circulation (accessory)

The settings for hot water circulation require the installation of an expansion card accessory.

DHW circulation is connected as shown in the schematic diagram. Pump G40 is used to circulate the hot water.

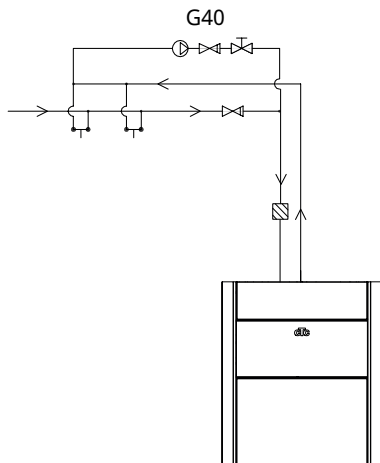

### 11.1.12 External heat source (EHS)

This function is used to connect additional heat sources to the heating circuit, e.g. water-jacketed stove, solar heat.

The heat from the external heat source is diverted into the system when the set temperature in the external tank is reached and is at least 5°C higher than the setpoint. Diversion stops when the temperature is 3°C higher. The compressor and immersion heater stay idle for as long as there is sufficient energy in the external heat source. Heat is diverted to both the heating circuit and to hot water.

This comes to an end when one of the following alarms occur: Supply sensor 1, HPin sensor, Communication fault. HP or if the supply sensor 1 is warmer than 80 °C.

Enter settings under Settings/External heat source.

NB: When an external heat source is connected to the heat pump, a magnetic filter should be fitted on the return flow between EHS and the heat pump to protect the heat exchanger.

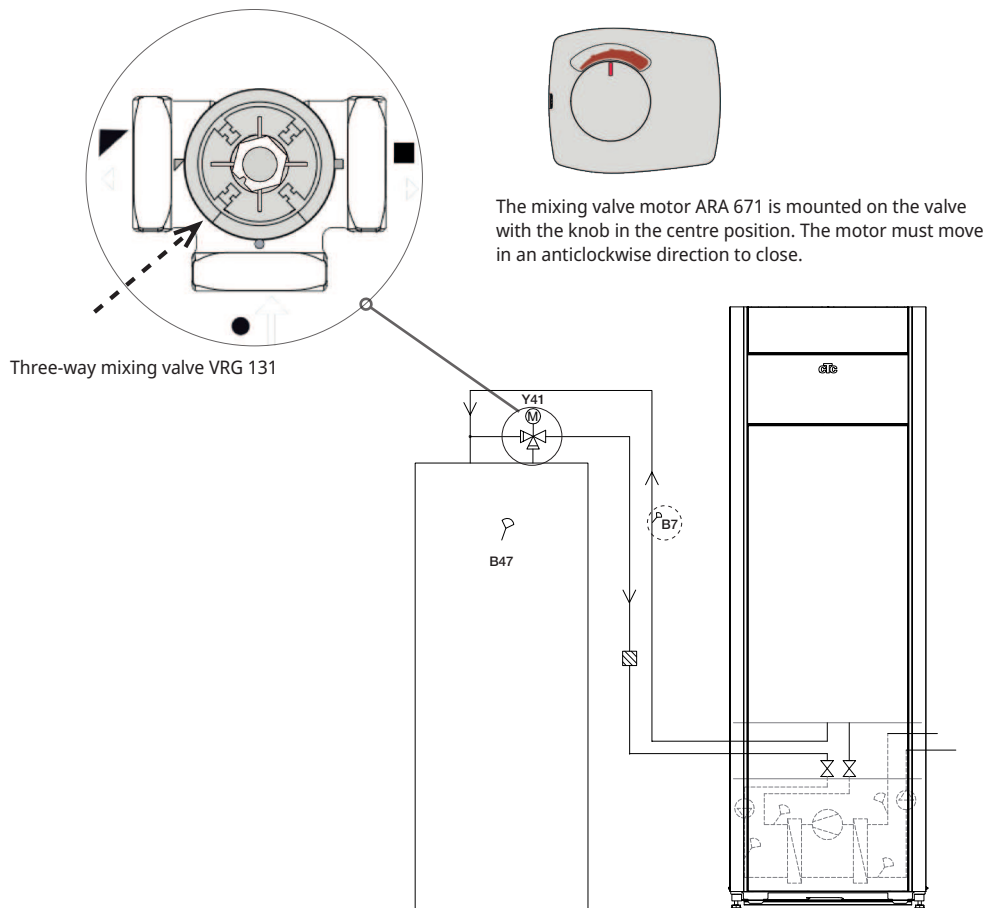

### 11.1.13 Diff thermostat function

The diff thermostat function is used if you want to transfer heat from a tank with the sensor (B46) to a tank with the sensor (B47).

The function compares the temperatures in the tanks and, when it is warmer in the first tank (B46), charging starts to the second tank (B47).

NB: For certain heat sources, e.g. solid fuel boilers, automatic chargers are recommended, among other things to counteract condensation in the fire box.

However, this function cannot be combined with solar system 2 with EcoTank. This is because the same circulation pump (G46) is used.

“Operation data/Diff thermostat function” displays the information “Status (On/Off).”

Ensure a high flow on the pump (G46) so that a low temperature difference of approx. 5-10 °C is achieved over the EHS tank during charging.

### 11.1.14 Pool (accessory)

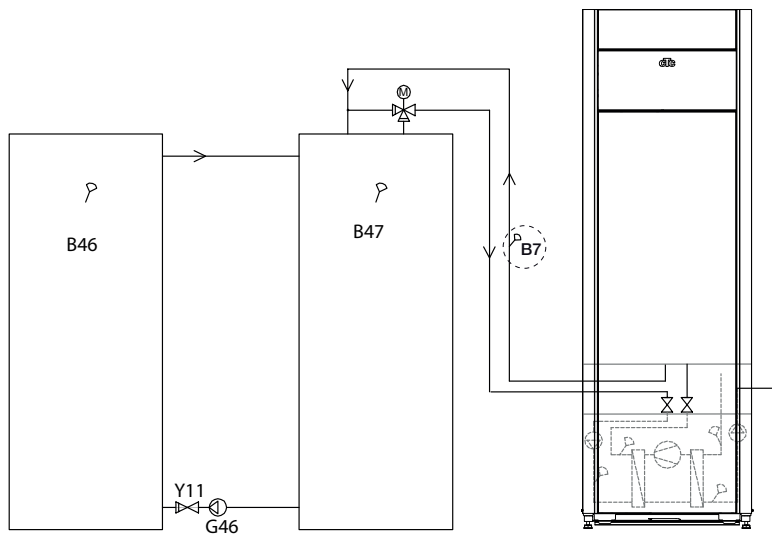

A pool can be connected to the system using a 3-way valve (Y50). A heat exchanger should be fitted to separate the liquids.

When the pool is heated, the 3-way valve (Y50) changes direction and the pool pump (G51) starts.

The immersion heater is never used to heat the pool. When a constant flow is desired in the pool water, the pool pump (G51) is connected with a separate supply and constant voltage.

The expansion card accessory is required to connect pool heating to your heating circuit.

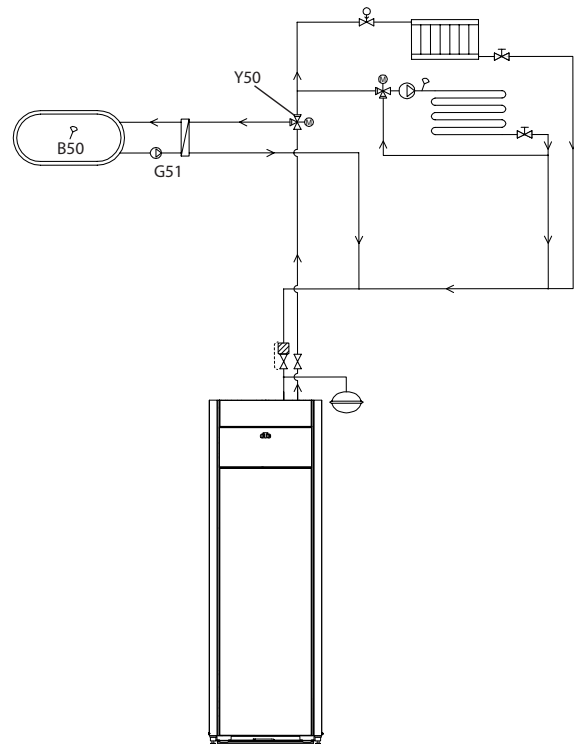

### 11.1.15 Schematic diagram, passive cooling Alt. 1 common cooling/heating

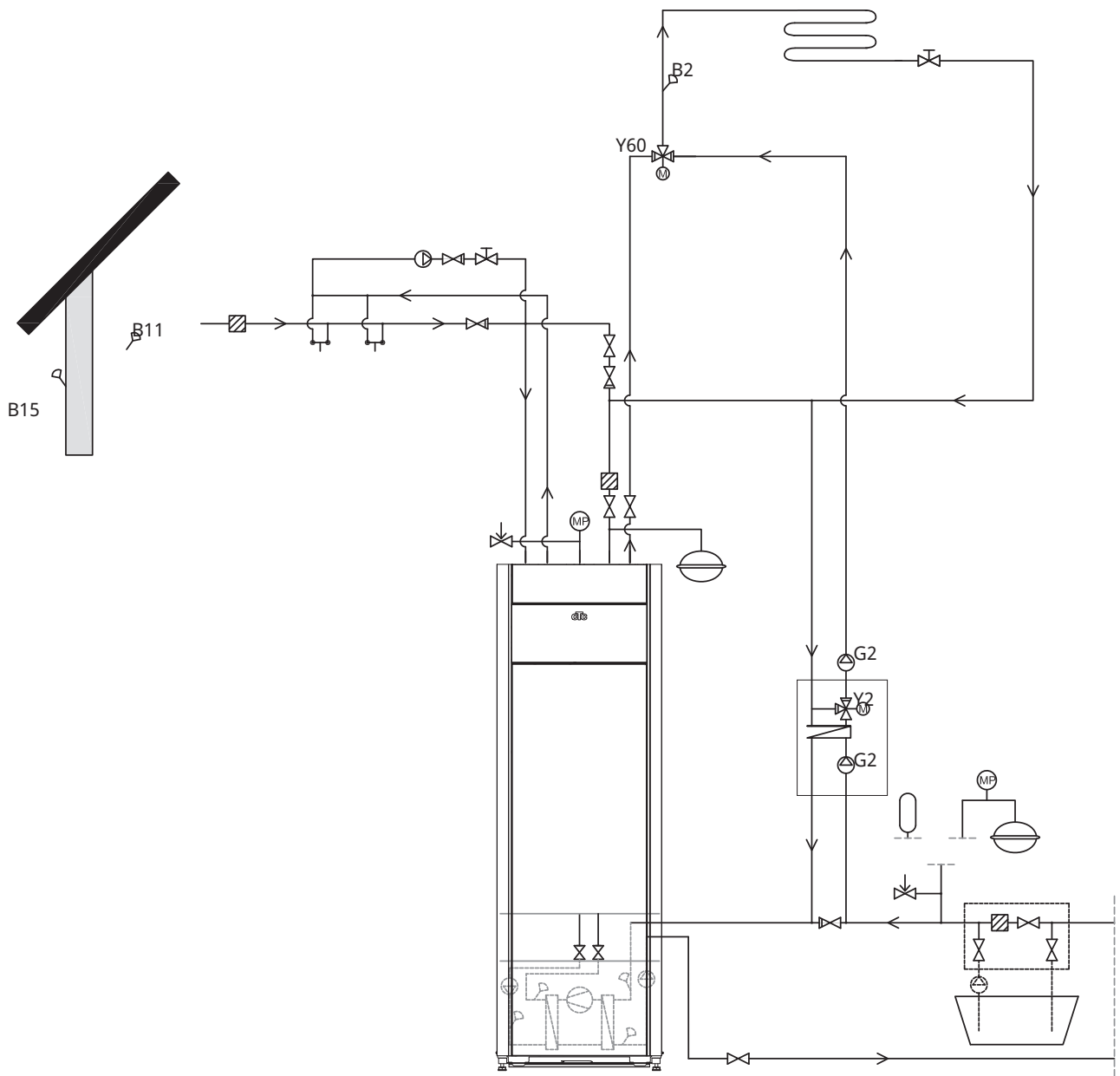

### 11.1.16 Schematic diagram, passive cooling Alt. 2 common cooling/heating

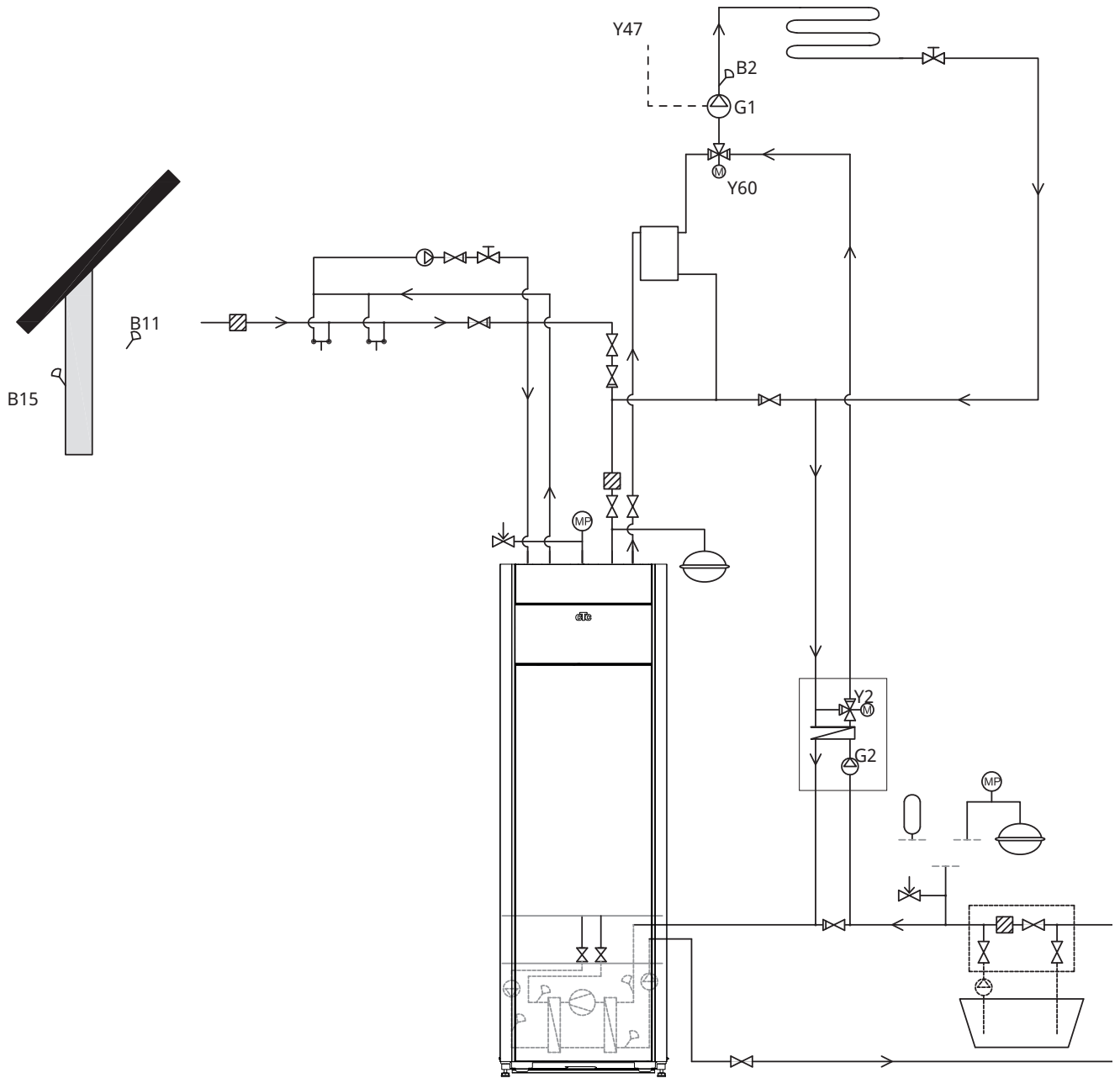

11.1.17 Schematic diagram, passive cooling Alt. 3

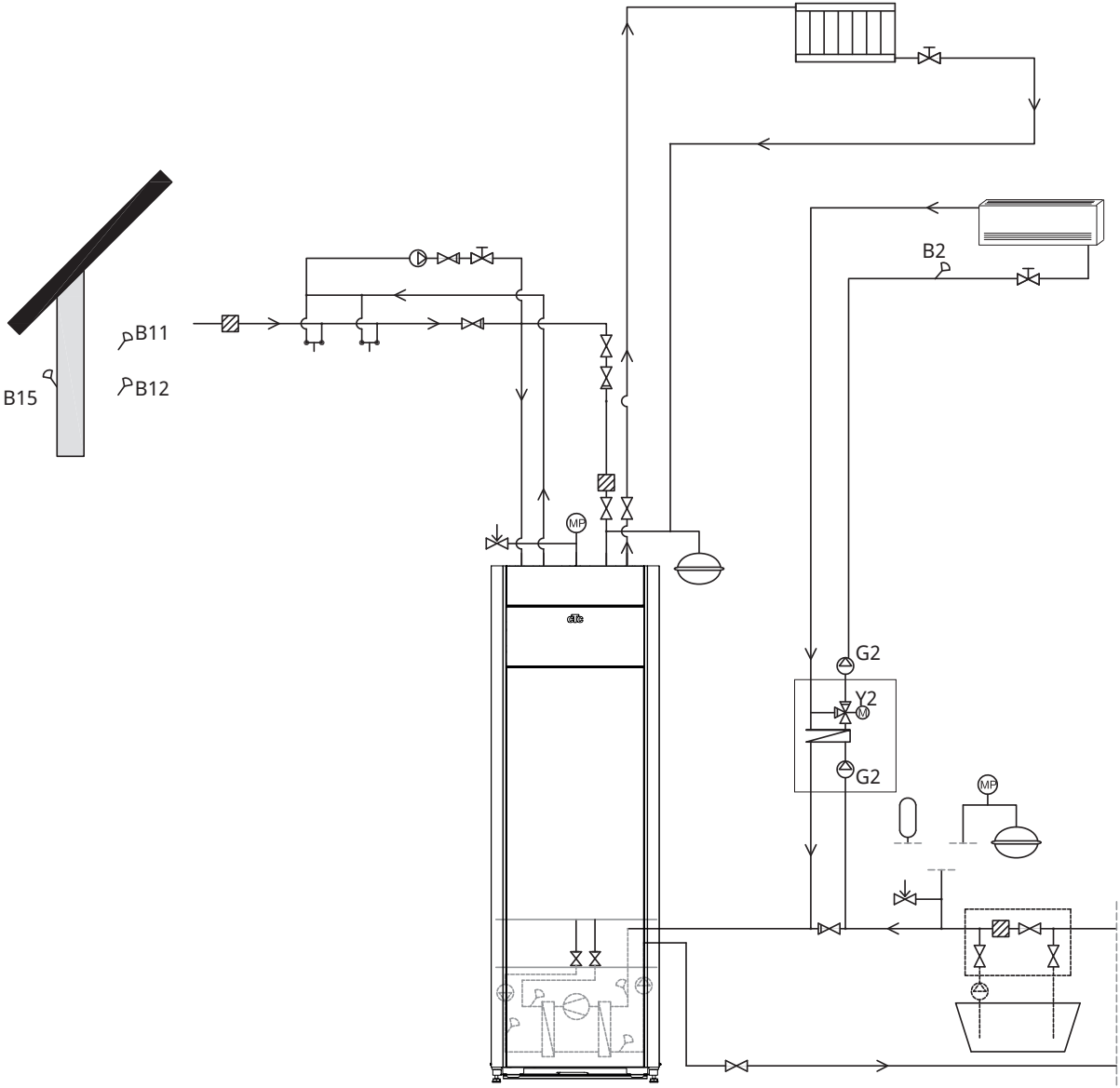

### 11.1.18 Solar heat (accessory)

Solar heat is connected to the system through an external heat source tank (EHS-tank).

The number of solar panels which can be connected depends on the volume of water in the product/tanks to which the solar panels are to be connected.

#### System 1

System 1 is a system structure with solar heat going directly to an external heat source tank (EHS-tank).

#### Charging conditions (main conditions, factory settings)

Charging starts when B31 is 7°C warmer than B47.

Charging stops when there is a difference of 3°C between B31/B30 or when the charge temperature is reached.

The external heat source tank (01) may also have a solar coil; this means that the heat exchanger (F2), pump (G32) or non-return valve (Y11) is not required.

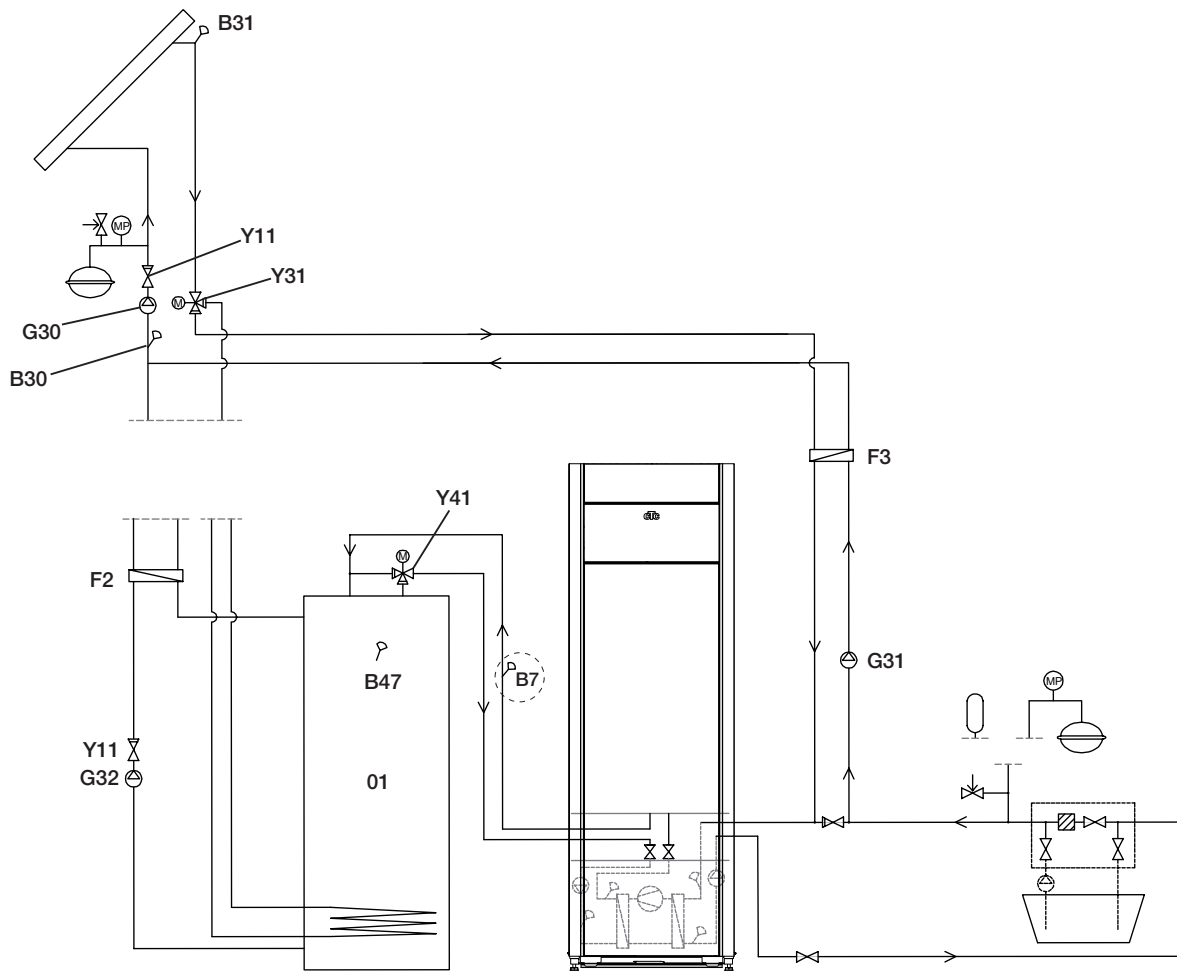

Schematic diagram only The installation engineer fits expansion tank, safety valves, bleeders, etc. and sizes the system.

## System 2

System 2 is a system structure with solar heat connected to an external heat source tank (EHS tank) and an extra buffer tank (CTC EcoTank for example). The system allows for a larger solar collector surface since it carries a greater volume of water.

### Charging conditions

Charging starts when B31 is 7°C warmer than B42.

Buffer tank without coil:

Charging stops when there is a difference of 3°C between B31/B30 or when the charge temperature is reached.

Buffer tank with coil:

For a tank with a solar coil, the charging stops instead when B31 is 3°C warmer than B42.

Charging of the EHS tank compares sensor B41 to sensor B47.

The buffer tank (02) may also have a solar coil; this means that the heat exchanger (F2), pump (G32) or non-return valve (Y11) is not required.

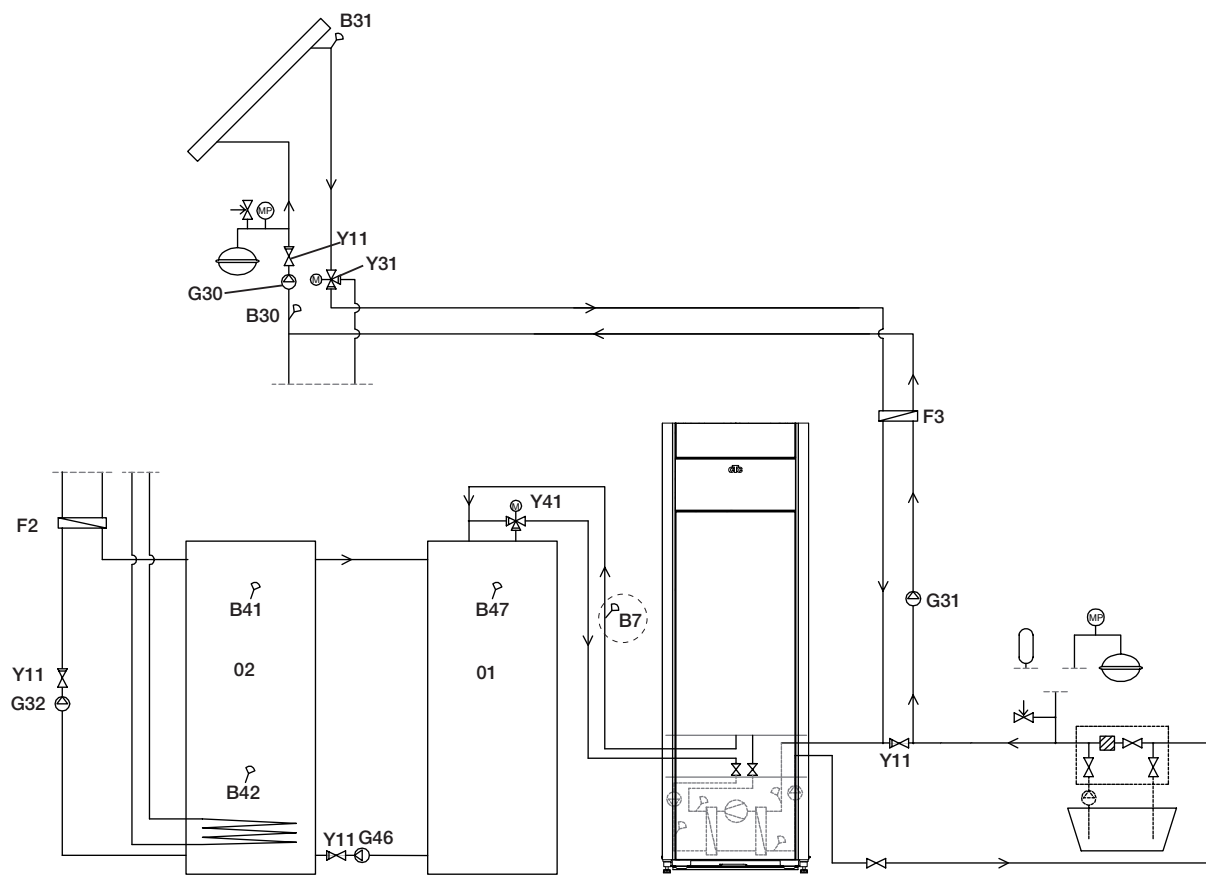

Schematic diagram only The installation engineer fits expansion tank, safety valves, bleeders, etc. and sizes the system.



### System 3

System 3 is a system structure with an extra volume called 03; this can be a large extra tank or a pool. The greater the volume of water, the greater the solar collector surface.

Solar heat is connected to an external heat source tank (EHS-tank) and an extra buffer tank (CTC EcoTank for example). The system allows for a larger solar collector surface since it carries a greater volume of water.

#### Charging conditions

Charging starts when B31 is 7°C warmer than B42 or B47.

Charging stops when there is a difference of 3°C between B31/B30 or when the charge temperature is reached.

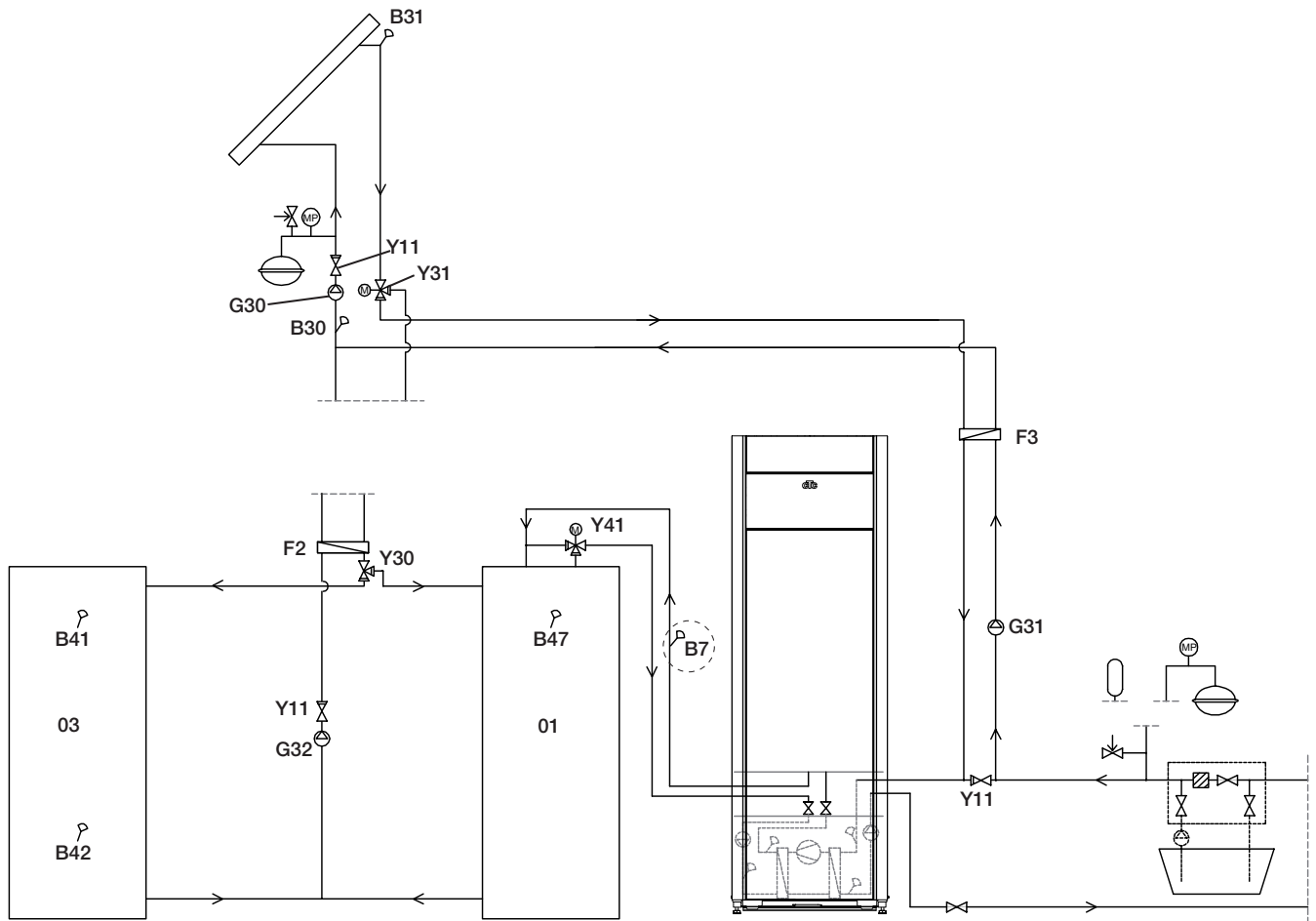

Schematic diagram only The installation engineer fits expansion tank, safety valves, bleeders, etc. and sizes the system.

### 11.1.19 Schematic diagram (complete diagram)

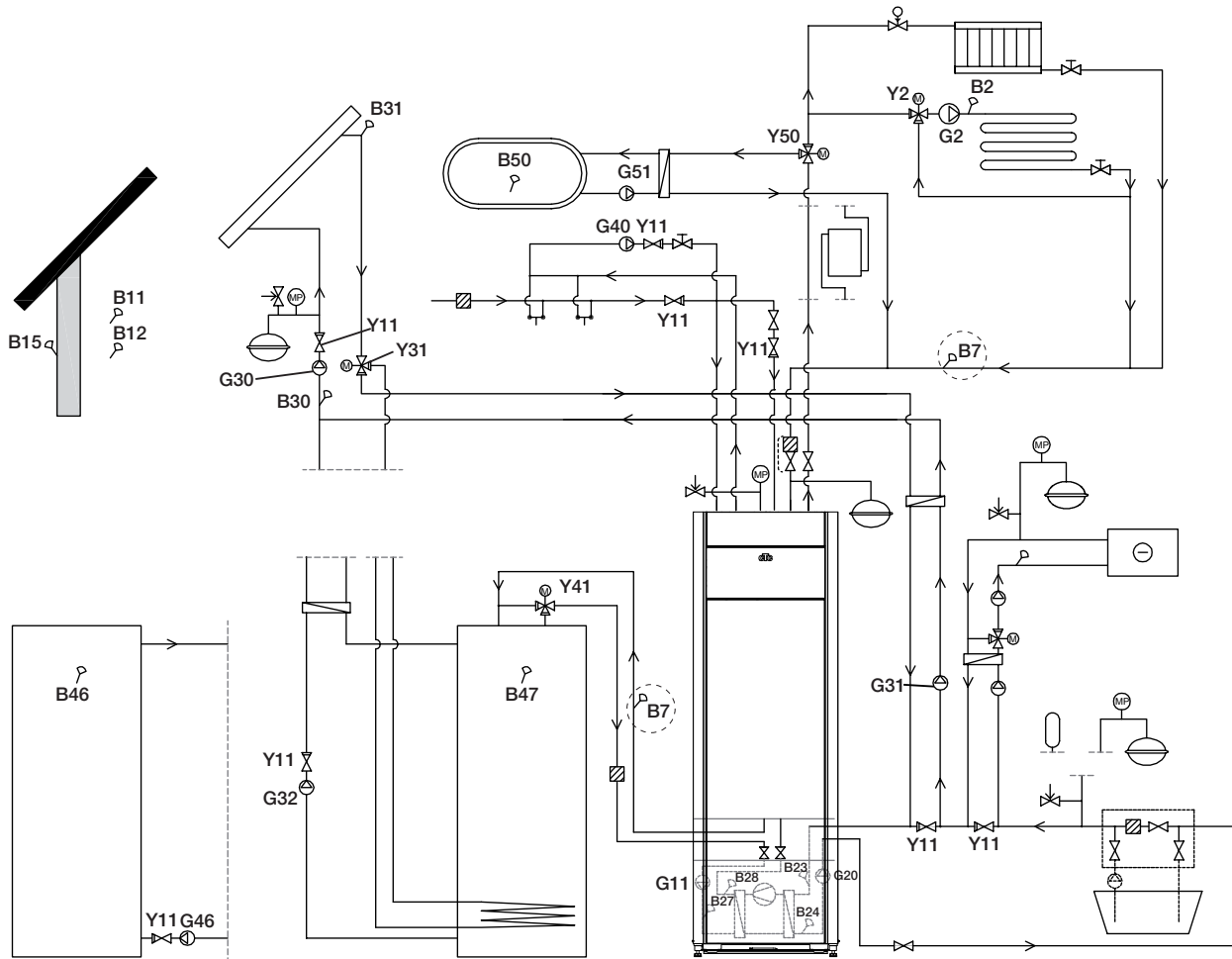

## 12. Connecting the brine system

The brine system, i.e. the ground collector loop, must be assembled and connected by a qualified tradesman in accordance with current regulations and design guidelines.

Care must be taken to ensure that no dirt gets on the collector hoses, which must be washed clean before being connected. The protective caps must always remain in place while work is in progress.

The temperature of the coolant system can fall below 0°C. It is therefore important that no water-based lubricants and similar are used during installation. It is also important that all the components are insulated against condensation to prevent the build-up of ice.

### 12.1 Connections

The brine system may be connected to the right, left or back of the heat pump. Cut away the cover plate on the side where the brine system is to be connected. The insulation on the inside of the cover plate has been grooved to enable an opening to be cut for the brine pipes provided. When the opening has been made through both the insulation and cover plate, carry out the installation as follows:

1. In order to protect the brine pipes, fasten the protective edging provided around the edge of the opening in the insulation plate. Adjust the length of the protective edging to suit the opening as required.
2. Attach the provided compression couplers to the cooling module connector pipes. To facilitate attachment, the upper brine pump connection may be loosened and rotated if necessary.
3. Pass the brine pipes through the opening in the side cover plates and connect them to the compression couplers. Ensure that the connections are well insulated to avoid the build-up of ice and condensation.
4. Install the collector system after this according to the schematic diagram.

You can also connect the primary flow on one side and the return on the other. See the section entitled "Measurement details for measurements and dimensions". The pipe between the heat pump and collector loop should have an internal diameter of no less than Ø28 mm.

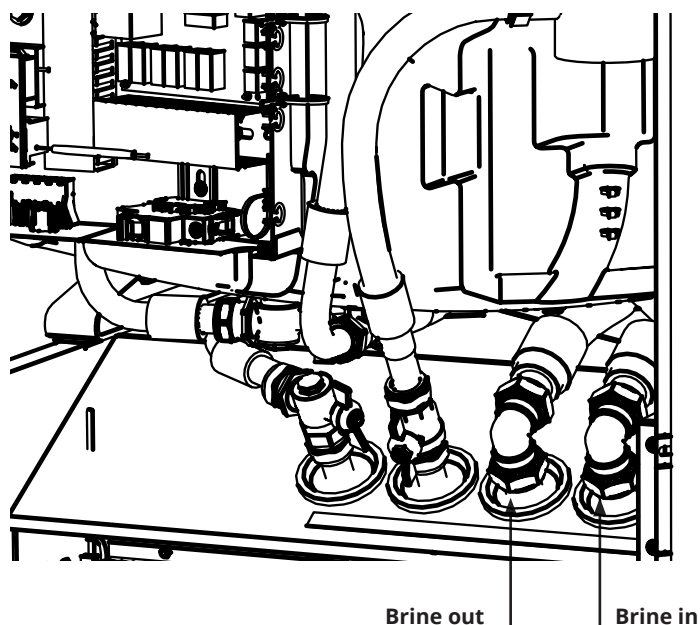

## 12.1.1 Connection options

### Left-side installation

1. Use the rear through-hole.
2. Push in the "brine out" pipe from the side.
3. Pull out the pipe from the front while pushing in the pipe from the side.
4. Fit the "brine in" pipe.
5. Push in the pipe from the side.
6. Pull out the pipe from the front while pushing in the pipe from the side.
7. Fit the "brine out" pipe.

If the pipe is pulled out from the front without pushing it in from the side at the same time, the pipe will be wedged with the insulation stuck under the tank and the insulation could be ruined.

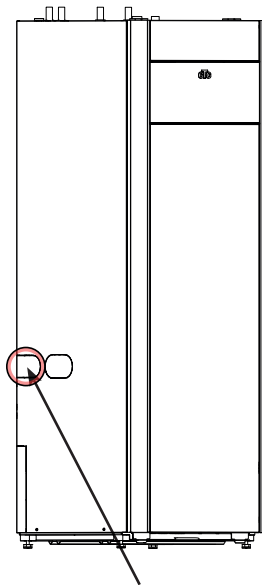

Left-side connection  
(Use rear outlet)

### Right-side installation

1. Use the rear through-hole.
2. Fit the "brine out" pipe.
3. Fit the "brine in" pipe.

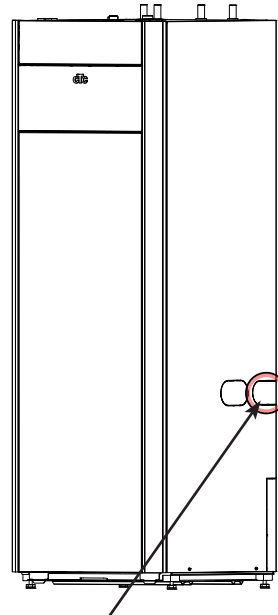

Right-side connection  
(Use front outlet)

### Rear installation

1. Use through-hole.
2. Fit the "brine out" pipe.
3. Push the pipe to the side under the tank.
4. Fit the "brine in" pipe.

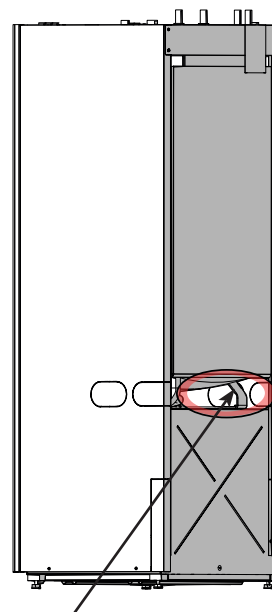

Connection, back

## 12.1.2 Valves

Fit the valves as shown in the schematic diagram on the next page. To facilitate servicing of the cooling unit, shut-off valves must be fitted to both the incoming and outgoing connections. Fit bifurcated valves so that it is possible to fill and bleed the collector circuit later on.

## 12.1.3 Insulation against condensation

All pipes in the brine system must be insulated against condensation to prevent the possibility of severe build-up of ice and condensation.

## 12.1.4 Filling and venting

The collector coil should not contain any air, as even the smallest amount of air can jeopardise the heat pump's operation.

Mix water and antifreeze solution in an open vessel. Connect the hoses to the shut-off valves (98a and 98b) as shown in the figure. NB: The hoses must have a minimum diameter of 3/4". Connect a powerful external pump (100) for refilling and bleeding. Open the valves (98a and 98b) so that the brine passes through the mixing container (101). Also make sure that the valve (98d) is open.

**If the heat pump is connected to the power supply, start the brine pump (102) as follows:**

- Open the "Installer/Service/Function Test" menu.
- Select the "Test heat pump/HP brine pump" option and activate it. The brine pump runs until it is manually stopped.

Allow the brine to circulate in the system for a long period of time until it is completely free of air. There could still be air in the system, even though no air accompanies the liquid out.

Bleed the level vessel (96) by loosening the plug on the top of the level vessel.

Now close the valve (98a) while the filling pump continues to run. The filling pump (100) now pressurises the system. Also close the valve (98b) and shut off the filling pump.

If the level in the level vessel is too low, close the valves (98c) and (98d).

Unscrew the plug and fill the vessel to around 2/3 full. Screw the plug back in and open the valves (98c) and (98d).

## 12.1.5 Pressure/level switch

In some cases, extra protection is required due to local requirements or provisions. For example, the requirement in some areas is for the system to be installed within a water catchment area. If there is a leak, the compressor and brine pump stop and the "Flow/level switch" alarm appears on the display. For connection, refer to the "Electrical Installation" chapter.

● Use the "Brine pump on 10 days" function to bleed the system properly.

## 12.2 Brine system schematic diagram

- 96 Level/expansion vessel
- 97 Filler manifold
- 98 Shut-off valves
- 99 Filter
- 100 External filling pump
- 101 Mixing vessel
- 102 Brine pump
- 103 Evaporator
- 104 Safety valve 3 bar

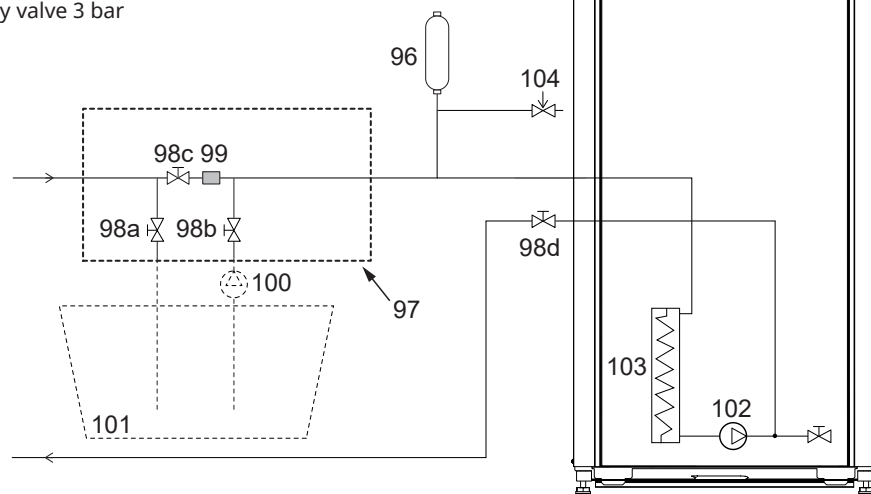

The diagram shows the main connection for the brine system. The filling equipment is represented by the parts displayed with dashes. NB: Collector hoses must have a bleeding facility as air pockets can occur. Always check the filter (99) when filling and bleeding the brine system.

### 12.2.1 Post-installation check on brine system

After a few days, you must check the fluid level in the vessel. Fill if necessary and close the valve (98c) when filling.

### 12.2.2 Level/expansion vessel (96)

The level vessel should be fitted to the incoming line from the borehole or ground loop, at the system's highest point. Bear in mind that the tank can produce condensate on its exterior. Fit the safety valve (104) as shown in the schematic diagram and fit a suitable plug to the top of the vessel.

If the vessel cannot be fitted at the highest point, a closed expansion vessel can be fitted.

### 12.2.3 Filler manifold with dirt filter

A filler manifold for topping up, adding and filtering brine. Arrows on the valve housing indicate the flow direction. Close valves (98c) when cleaning the filter. Unscrew the filter cap and flush the filter clean. When refitting, the pin under the filter should be fed into the designated hole in the filter housing. Top up with a little brine, if necessary, before fitting the cap. The filter should be checked and cleaned after a short period of operation.

**!** The mixing vessel and pump must be of a good size.

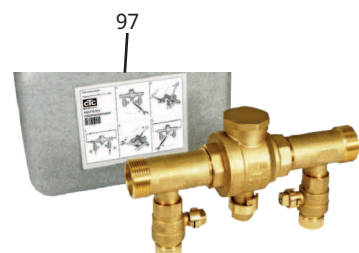

## 12.2.4 Brine

The brine circulates in a closed system. The fluid consists of water and antifreeze solution. Sentinel R500 & R500C are recommended for use in the brine circuit. The glycol is mixed at a concentration of slightly less than 30%, which is equivalent to fire risk class 2b and a freezing point of around  $-15^{\circ}\text{C}$ .

It is a CTC recommendation that around 1 litre of brine/glycol is required per metre of collector hose, i.e. around 0.3 litres of antifreeze solution will be needed per metre of hose, for an (external) hose diameter of 40 mm.

## 12.2.5 Air pockets

To avoid air pockets, make sure that the collector hoses constantly rise towards the heat pump. If this is not possible, it must be possible to bleed the system at the high points. The filling pump usually manages smaller local height discrepancies.

## 12.2.6 Checking brine difference

When the heat pump is running, regularly check that the temperature difference between incoming and outgoing brine temperatures is not too large. If there is a large difference, one of the causes may be due to air in the system or a blocked filter. If this is the case, the heat pump triggers the alarm.

The alarm factory setting is  $7^{\circ}\text{C}$ , but  $9^{\circ}\text{C}$  is permitted for the first 72 hours while the compressor is running, as microbubbles in the system can reduce brine flow.

 Check the dirt filter after bleeding has been completed.

 The fluid must be thoroughly mixed before the heat pump is started.

 Check the dirt filter in the brine system after a few days' operation.

## 12.2.7 Pressure differential diagram - cold side

CTC GS 606 / 608

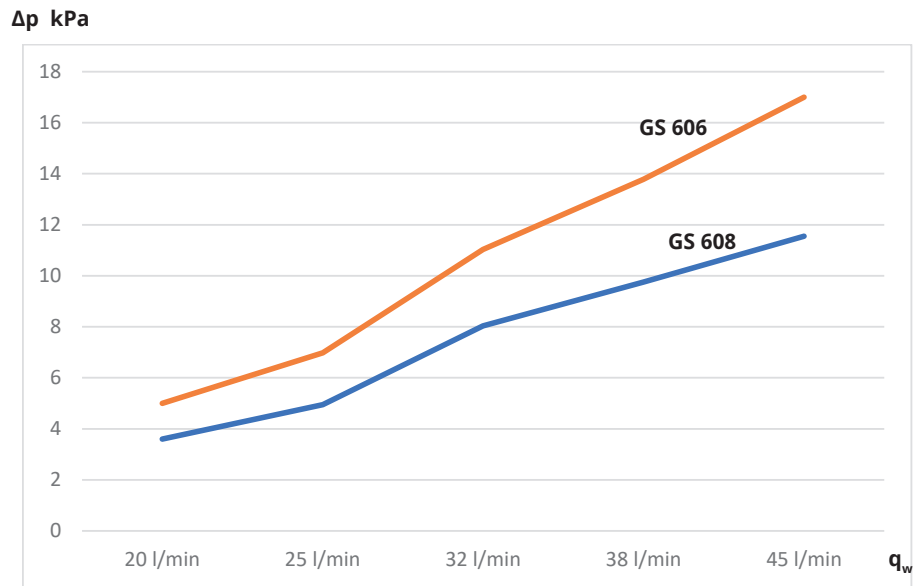

## 12.2.8 Coolant pump (G20)

CTC GS 606 / 608

25/125-180 PWM, 1x230 V, 50/60 Hz

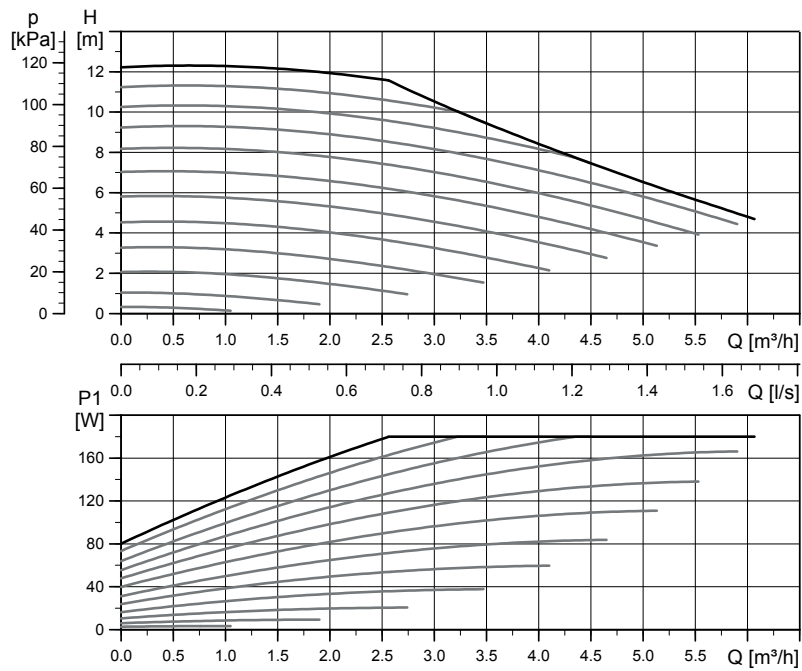



# 13. Electrical installation

## Safety information

Electrical installation must be performed in compliance with specific requirements in the national electrical safety standard. The following safety instructions must be observed when handling, installing and using the product:

- Turn off the power with an omnipolar switch before doing any work on the product.
- Damaged feed cables must be replaced by the manufacturer or a qualified service engineer in order to avoid any risks.
- The product is classified as IPX1. The product must not be rinsed with water.
- Never jeopardise safety by removing bolted covers, hoods or similar.
- Never jeopardise safety by deactivating safety equipment.
- Installation and heat pump connection must be performed by an authorised electrician. All wiring must be installed according to applicable provisions. The boiler's internal wiring is installed at the factory.

To open the front panel: 1. Remove magnetic strip 2. Loosen the two screws on top. 3. Fold out and set the front to the side. 4. Bear in mind that the cable to the display on the front is sensitive to damage.

## Supply

The power supply cable is connected at (1). Length 200 cm.

The group fuse is selected such that all relevant requirements for the electrical installation are met; see technical data. The size of the fuse is set in the installation flow on the touchscreen. The product adjusts the electrical power according to this. Once a current sensor has been installed, the built-in load switch is able to regulate the immersion heater's electrical output based on the set main fuse.

## Omnipolar safety switch

The installation should be preceded by an omnipolar safety switch according to overvoltage category III, which ensures disconnection from all electric power sources.

## Residual current device

If there already is a ground fault breaker, the product must also be fitted with its own ground fault breaker with on/off delay.

## Max thermostat

If the product has been stored in an extremely cold place, the max. thermostat may have been triggered. Reset it by pressing in the button on the electrical switchboard behind the front panel. Always check on installation that the max thermostat has not tripped.

## Extra low voltage protection

The following outputs and inputs have extra low voltage protection: current transformer, outdoor sensor, room sensor, primary flow sensor, return sensor, NR/SO.

## Accessory: expansion card (A3)

For certain system options the product must be supplemented with the expansion card accessory (A3). See the manual provided for how to install the card. Settings which are entered after installation are found in this manual.

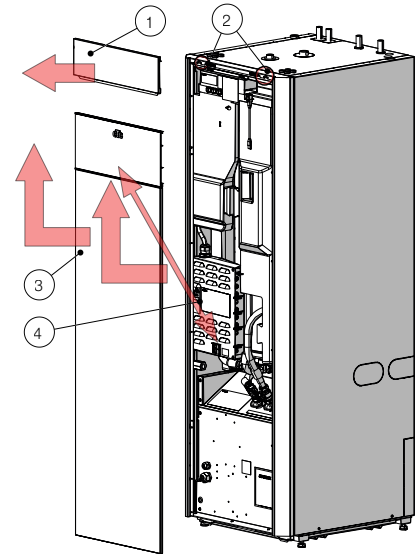

\*Immersion heater, delivery setting

	Heat (kW)	DHW (kW)
400V 3~	9.0/5.8 (GSI/GS 608)	0
230V 1N~	5.5	0
230V 3~	7.0	0

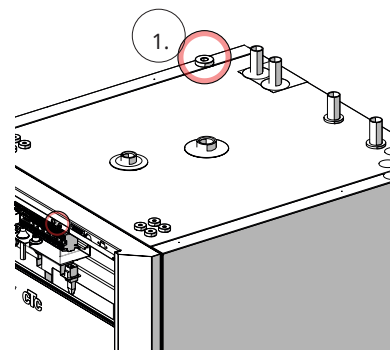

Positioning of supply cable.



Symbol for max thermostat.

## 13.1 Sensor connection

Sensor connection is carried out on top of the main product.

### Sensor terminal block

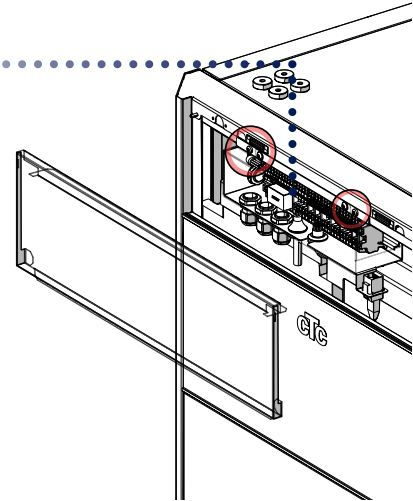
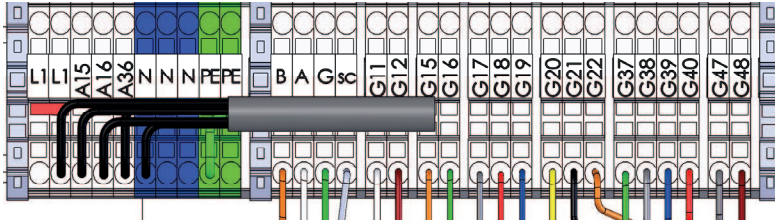

### Connection of outdoor sensor (B15)

The outdoor sensor is connected to G11-G12 on the sensor terminal block.

The sensor should be set up on the house's northwest or north side, so that it is not exposed to morning and evening sun. If there is a risk of the sensor being affected by the sun's rays, it must be protected by a screen.

Place the sensor at around 2/3 of the height of the facade near a corner, but not under a roof projection or other form of wind protection. Do not place it either above ventilation ducts, doors or windows where the sensor may be affected by factors other than the actual outdoor temperature.

### Connection of room sensors (B11 and B12)

Connect room sensor 1 to G17-G19.

Connect room sensor 2 to G20-G22.

The room sensor is fitted at a central point in the house, in the most open position possible, ideally in a hall between several rooms. This is the best position for the sensor to record an average temperature for the house.

Feed a three-conductor cable (minimum 0.5 mm<sup>2</sup>) between the heat pump and room sensor. Then attach the room sensor securely in a position roughly two thirds of the way up the wall. Connect the cable to the room sensor and heat pump.

When connecting a wireless room sensor (accessory), refer to the accessory's manual.

#### Check room sensor connection

- Open the "Installer/Service/Function Test/Heating Circuit" menu.
- On the row "LED room sensor", press "OK".
- Select "On" using the "+" button and press "OK". Check that the room sensor LED lights up. If not, check the cables and connection.
- Select "Off" using the "-" button and press "OK". If the OK LED goes off, the check is complete.
- Return to start menu by pressing the "Home" button.

Do not attach the sensor cable permanently until you have tested where the best location is.

Room sensor 1 (B11)

Sensor terminal block	Terminal block, room sensor
G17	#1 (alarm)
G18	#2
G19	#4

Room sensor 2 (B12)

Sensor terminal block	Terminal block, room sensor
G20	#1 (alarm)
G21	#2
G22	#4

## 13.2 Checking connected sensors

If any sensor is incorrectly connected, a message will appear on the display, e.g. "Alarm: [E030] sensor out". If several sensors are incorrectly connected, the different alarms are displayed on different rows.

If no alarm is displayed, the sensors are connected correctly.

## 13.3 Pressure/level switch

The pressure/level switch is connected to blocks G73 and G74 and then defined under the Installer/Define system/Def Heat pump menu.

## 13.4 Setting electrical output in backup power supply

The DIP switch on the relay card (A2) is used to set the backup power supply. The DIP switch is marked "RESERV" (BACKUP).

When the switch is set to ON, the step is actively operating in backup heating mode.

Set the value according to the requirements and capacity of the property.

### 3x400V

Relay	EL3A	EL2B	EL2A	EL1B	EL1A
Factory setting	ON	OFF	ON	OFF	ON
Current	5.2 A	10 A	2.6 A	10 A	1.3 A
Output	1.2 kW	2.3 kW	0.6 kW	2.3 kW	0.3 kW

### 1x230V

Relay	EL3A	EL2B	EL2A	EL1B	EL1A
Current	-	10.0 A	2.6 A	10.0 A	1.3 A
Output	-	2.3 kW	0.6 kW	2.3 kW	0.3 kW

### 3x230V

Relay	EL3A	EL2B	EL2A	EL1B	EL1A
Current	-	5.9 A	3.0 A	5.9 A	3.0 A
Output	-	1.567kW	0.780 kW	1.567kW	0.780 kW

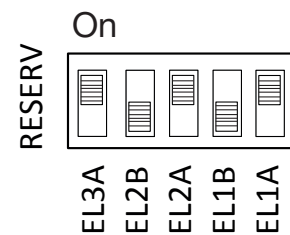

Example for 3x400V:  
 $1.2 + 0.6 + 0.3 = 2.1 \text{ kW}$   
 (Factory-set value)

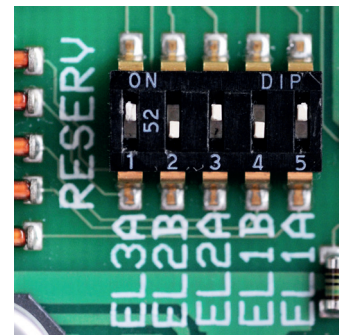

## 13.5 Pump Diff thermostat function (G46) on/off

230V 1N~

Sensor (B46) is connected to the relay card (A2) at terminal block G65–G66.

Circulation pump G46 is connected to the following terminal blocks:

Phase:	brown	Terminal block A:11
Zero:	blue	
Earth:	yellow/green	

Check the function by test running the pump in the "Installer/Service/Function Test" menu in the control system.

## 13.6 Heating circuit 2 (alt. Passive cooling)

Primary flow sensor 2 (B2) NTC 22k is connected to terminal blocks G15-G16 on the sensor terminal block.

fit the primary flow sensor to the primary flow pipe, ideally after the circulation pump.

The sensing part is towards the end of the sensor (see sketch).

- Attach the sensor using the cable tie provided.
- Ensure that the sensor makes good contact with the pipe.  
Apply contact paste to the front part of the sensor between the sensor and the pipe if good contact is otherwise difficult to obtain.
- **Important!** Insulate the sensor using pipe insulation.
- Connect the cables to the sensor terminal block at position G15-G16.

Mixing valve 2 (Y2) is connected to terminals blocks A15, A16 and zero on the sensor terminal block:

Black	Open	Terminal block A15
Brown	Close	Terminal block A16
Blue	Zero	N

Radiator pump 2 (G2) is connected to terminals block A36 as well as zero and earth on the sensor terminal block:

Brown		Terminal block X2/ A36
Blue	Zero	X2/N
Yellow/green	Earth	X2/PE

Passive cooling is adjusted using primary flow sensor 2 (B2), which then means that heating circuit 2 and cooling cannot be used simultaneously.

For a combined underfloor heating and passive cooling system, the 3-way valve (Y60) must be connected as follows:

Black	Relay output	Terminal block X2/ A36
Brown	Phase	Terminal block X2/L1
Blue	Zero	Terminal block X2/N

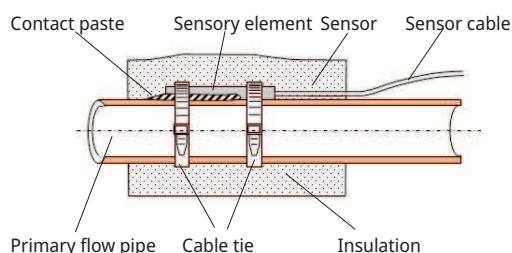

## 13.7 Pool (accessory)

Connect the sensor (B50) which measures the pool temperature at expansion card (A3) terminal block X3: 15-16.

Connect the circulation pump (G51) to expansion card (A3) as below:

Phase:	brown	Terminal block X7: 33
Earth:	yellow/green	Terminal block X7: 34
Zero:	blue	Terminal block X7: 35

Connecting the 3-way valve (Y50):

Control voltage	Black	Terminal block X7:24
Phase	Brown	Terminal block X7:25
Zero	Blue	Terminal block X7:26

Check the function by test running the pump in menu "Installer/Service/Function test".

## 13.8 External heat source (EHS)

The sensor (B47) from the external heat source is connected to the relay card (A2) at terminal block G67-68.

Connection for controlling the mixing valve (Y41) is done as follows:

Black cable	Open	Terminal block A27
Brown cable	Close	Terminal block A28
Blue cable	Zero	Terminal block A29

## 13.9 CTC EcoVent (accessory)

To connect the CTC EcoVent ventilation product, please refer to the CTC EcoVent manual.

## 13.10 CTC SmartControl (accessory)

To connect CTC SmartControl, please refer to the separate CTC SmartControl manual.

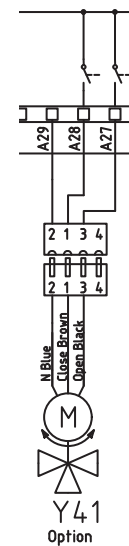

## 13.11 Solar heat (accessory)

### Pump solar panel (G30) PWM

230V 1N~

Circulation pump G30 is powered separately (not from this unit). The PWM control signal is connected to the following terminal blocks:

Expansion card (A3) X5:

Note the cable colours!

PWM+:	white	Terminal block X5: 1
GND:	brown	Terminal block X5: 2

Check the function by test running the pump in the "Installer/Service/Function Test" menu in the control system.

### Pump intermediate heat exchanger solar panels (G32) PWM

230V 1N~

Pump G32 is powered separately (not from this unit). The PWM control signal is connected to the following terminal blocks:

Expansion card (A3) X5:

Note the cable colours!

PWM+:	blue	Terminal block X5:3
GND:	brown	Terminal block X5:4

Check the function by test running the pump in the "Installer/Service/Function Test" menu in the control system.

### Pump bedrock (G31) on/off

230V 1N~

Circulation pump G31 is connected at the following terminal blocks:

Expansion card (A3) X6:

Note the cable colours!

Phase:	brown	Terminal block X6:8
Zero:	blue	Terminal block X6:11
Earth:	yellow/green	Terminal block X6:10

Check the function by test running the pump in the "Installer/Service/Function Test" menu in the control system.

### Valve 2 tanks (Y30)

230V 1N~

3-way valve Y30 is connected at the following terminal blocks:

Expansion card (A3) X6:

Control voltage:	black	Terminal block X6:4
Phase:	brown	Terminal block X6:5
Zero:	blue	Terminal block X6:7

## Valve bedrock (Y31)

230V 1N~

3-way valve Y31 is connected with pump G31 at the following terminal blocks:

Expansion card (A3) X6:

Control voltage:	black	Terminal block X6:8
Phase:	brown	Terminal block X6:9
Zero:	blue	Terminal block X6:11

## 13.12 Current sensor connection (accessory)

The current sensors are connected at G37–G40 on the sensor terminal block.

The three current sensors, one for each phase, are fitted on the fuse panel. Each phase from the electricity distribution board supplying the product is channelled through a current sensor before termination at the relevant terminal. This allows the phase current to be sensed all the time and compared with the value set for the heat pump's load switch. If the current is higher, the control unit drops to a lower heat output on the immersion heater. If this is insufficient, the heat pump is also limited. When the power drops back below the set value, the heat pump and immersion heater are reconnected. This means that the current sensors, along with the electronics, prevent more power being supplied than the main fuses can tolerate.

The current sensors' cable holes are 11 mm in diameter.

The current sensor connection has no alarm, but the current value can be read in the "Operation data" menu. Note that the tolerance/accuracy is very low with small current values.

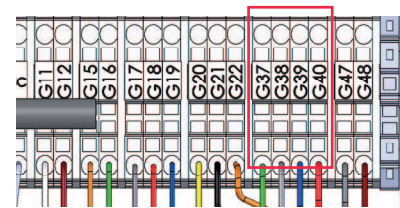

Connect to G37–G40 on the sensor terminal block. Use at least a 0.5 mm<sup>2</sup> cable.

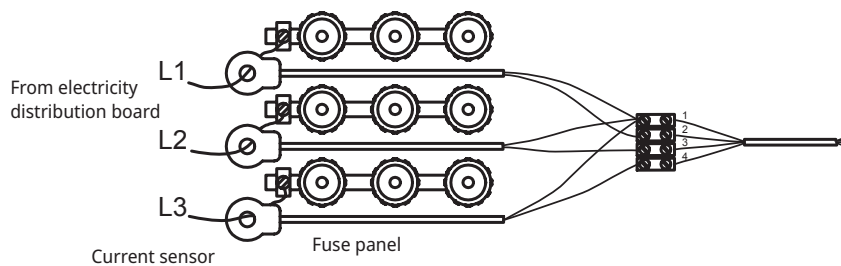

### 13.13 Electrical diagram tank (A2), 3x400V /1.

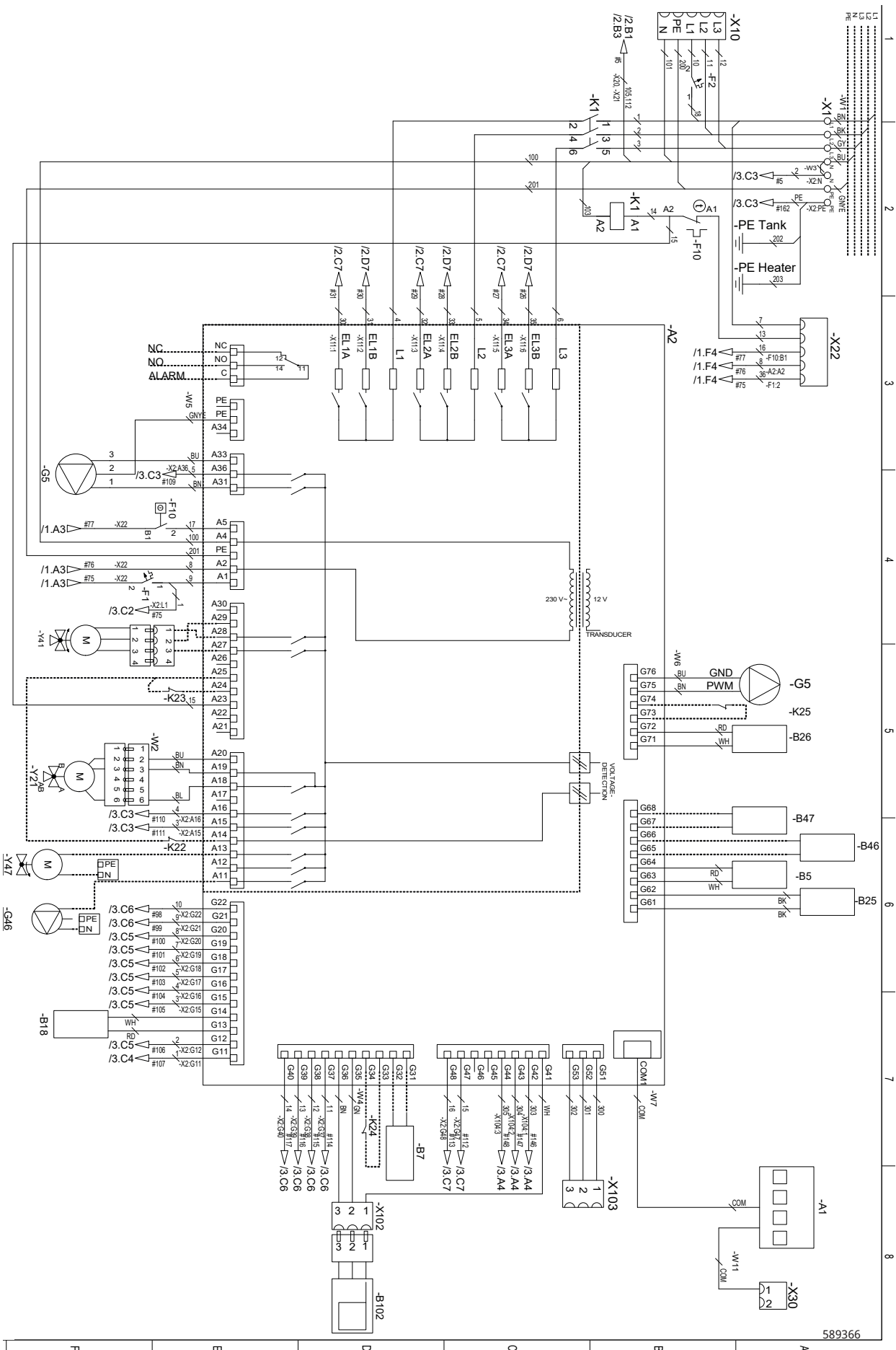

589366



### 13.14 Flow heater (E15), 3x400V /2.

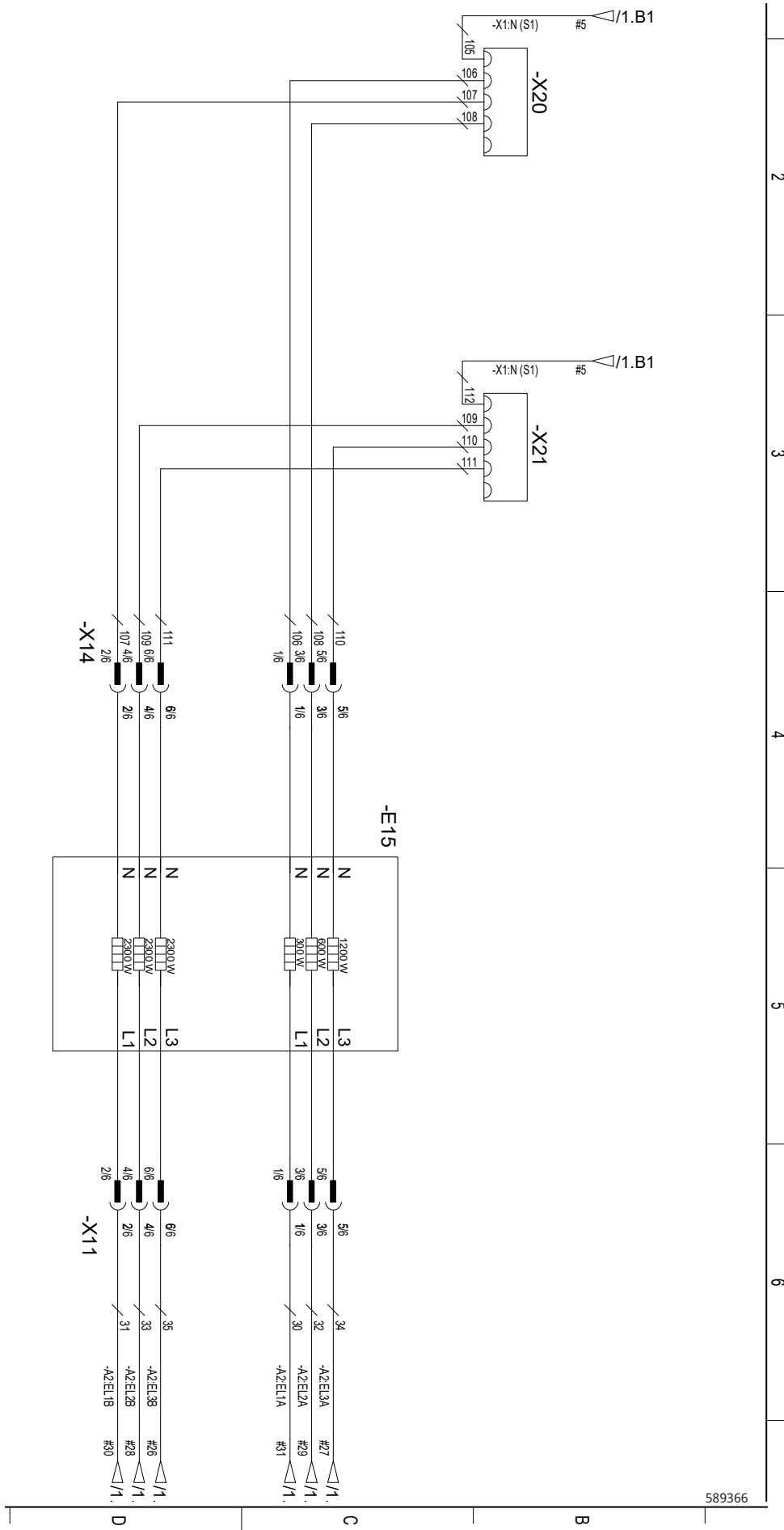

589366

### 13.15 Terminal block (X2), 3x400V /3.

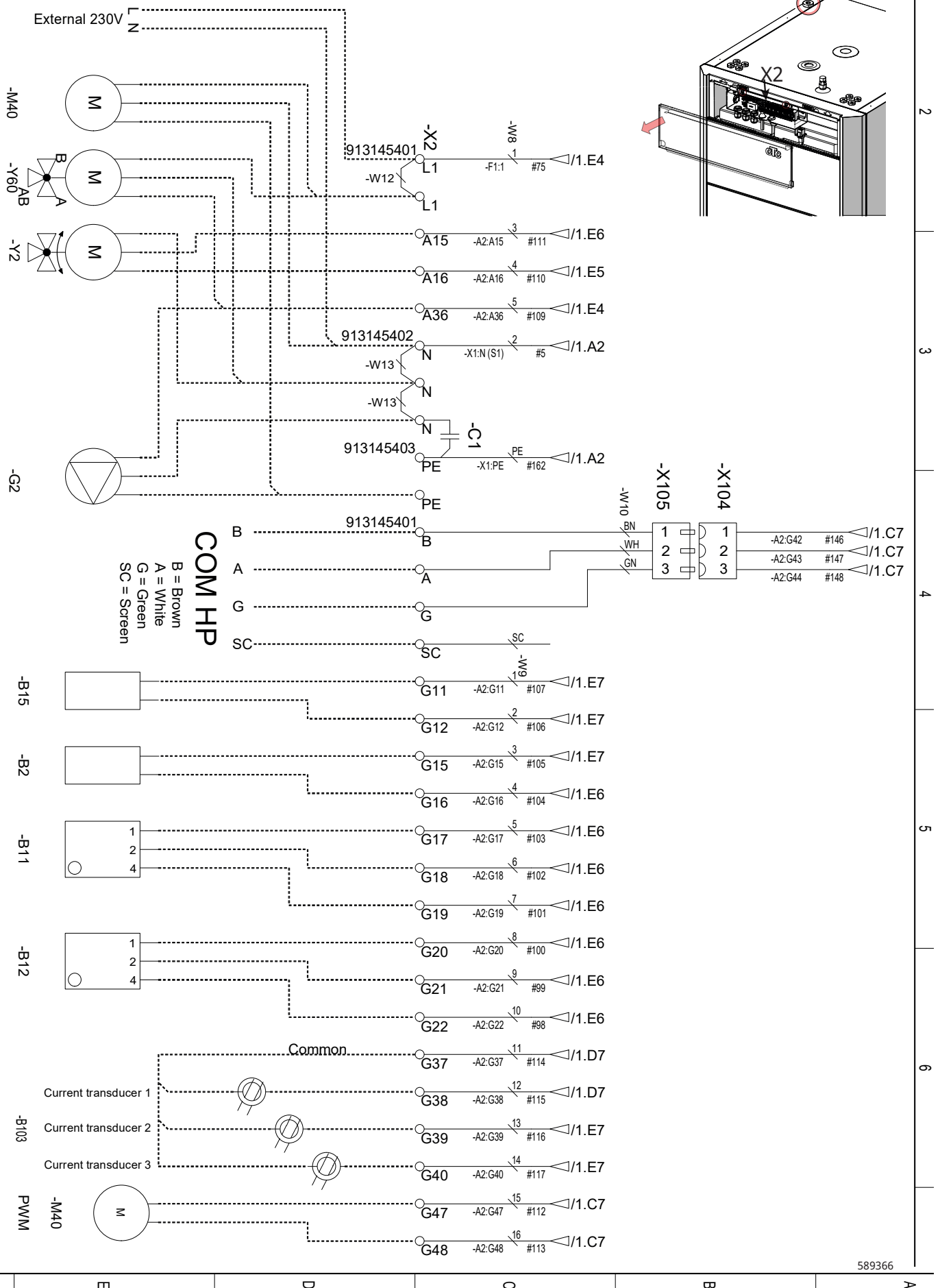

589366

### 13.16 Electrical diagram tank (A2), 1x230V /1.

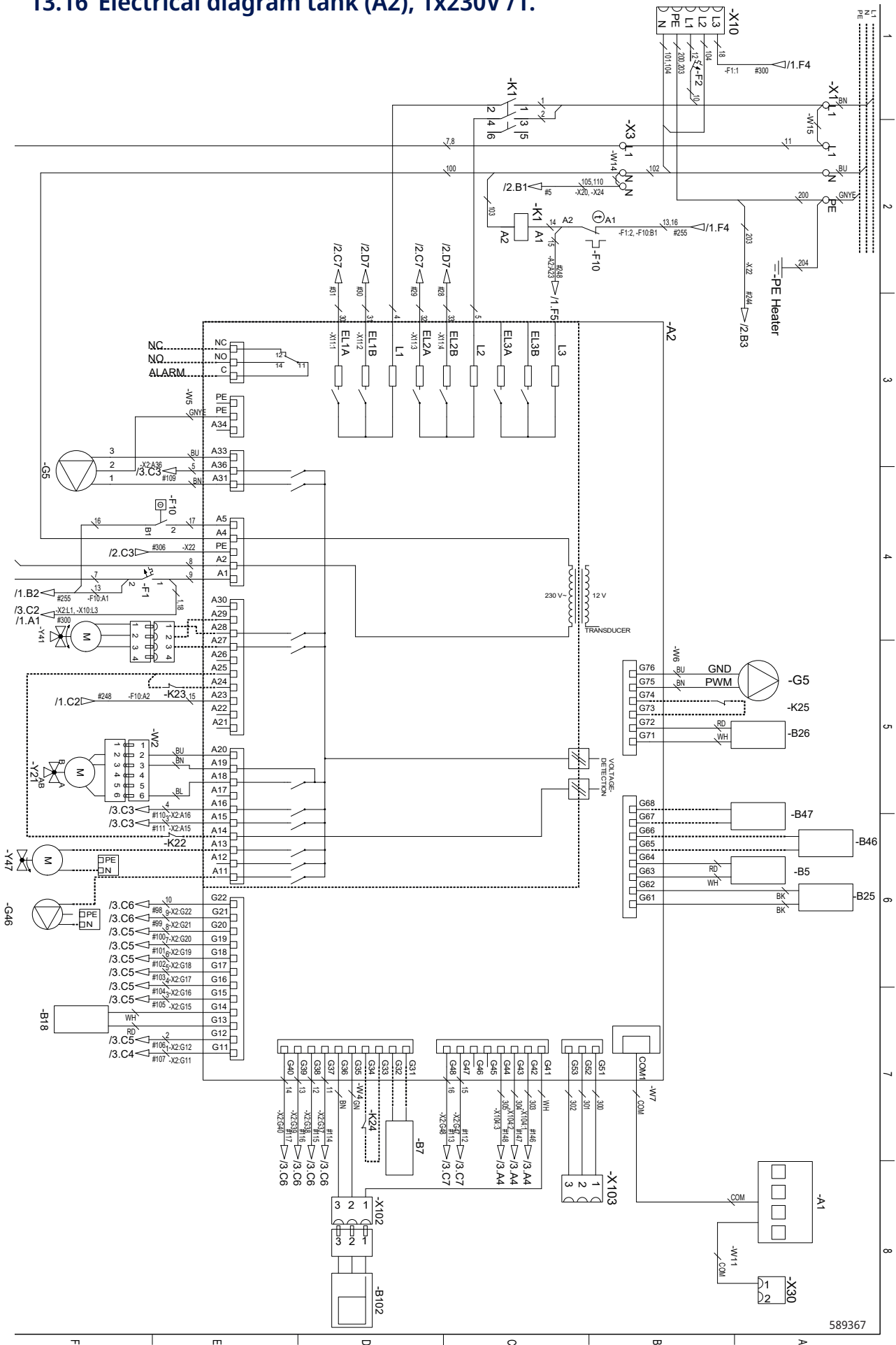

### 13.17 Flow heater (E15), 1x230V /2.

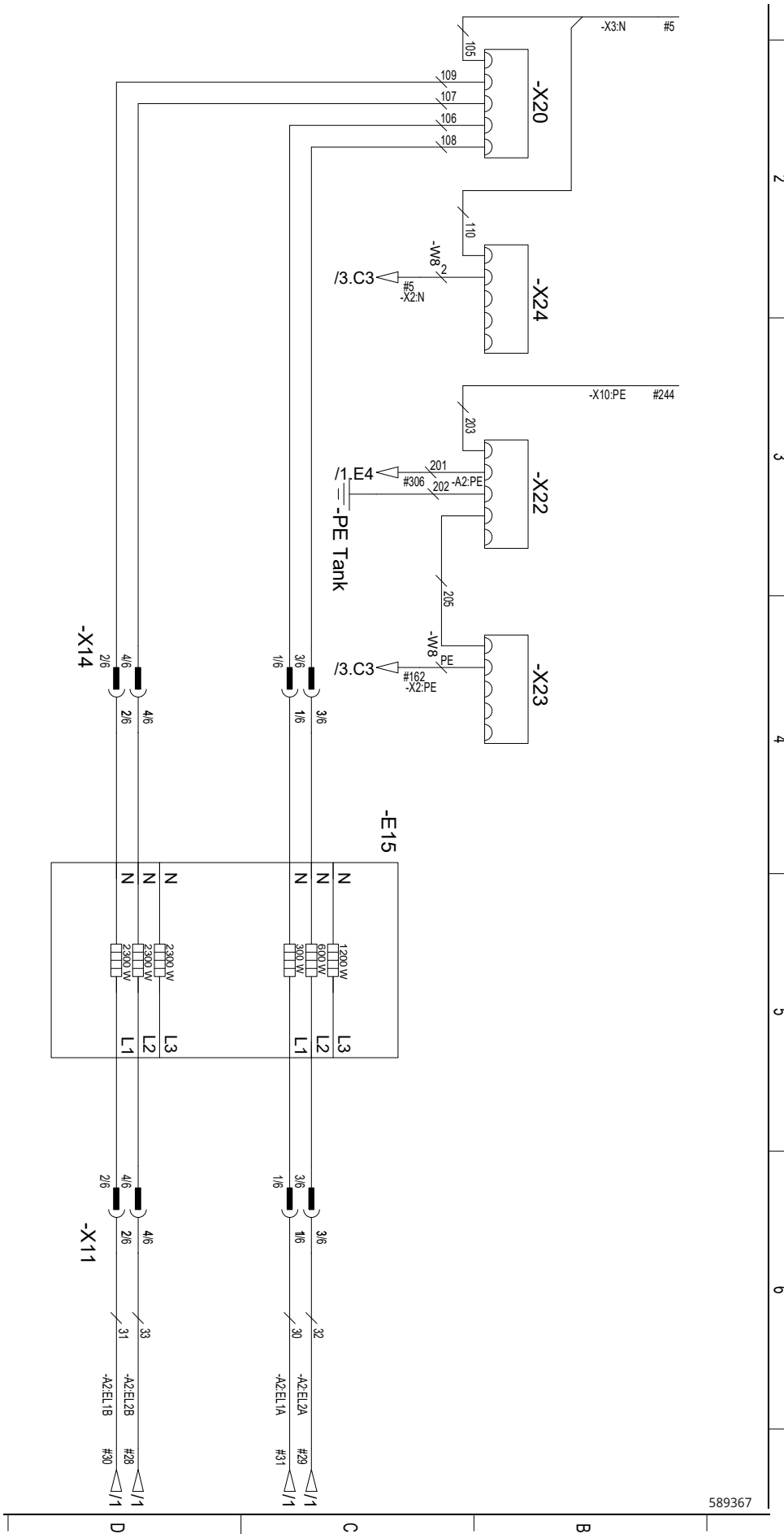

589367

### 13.18 Terminal block (X2), 1x230V /3.

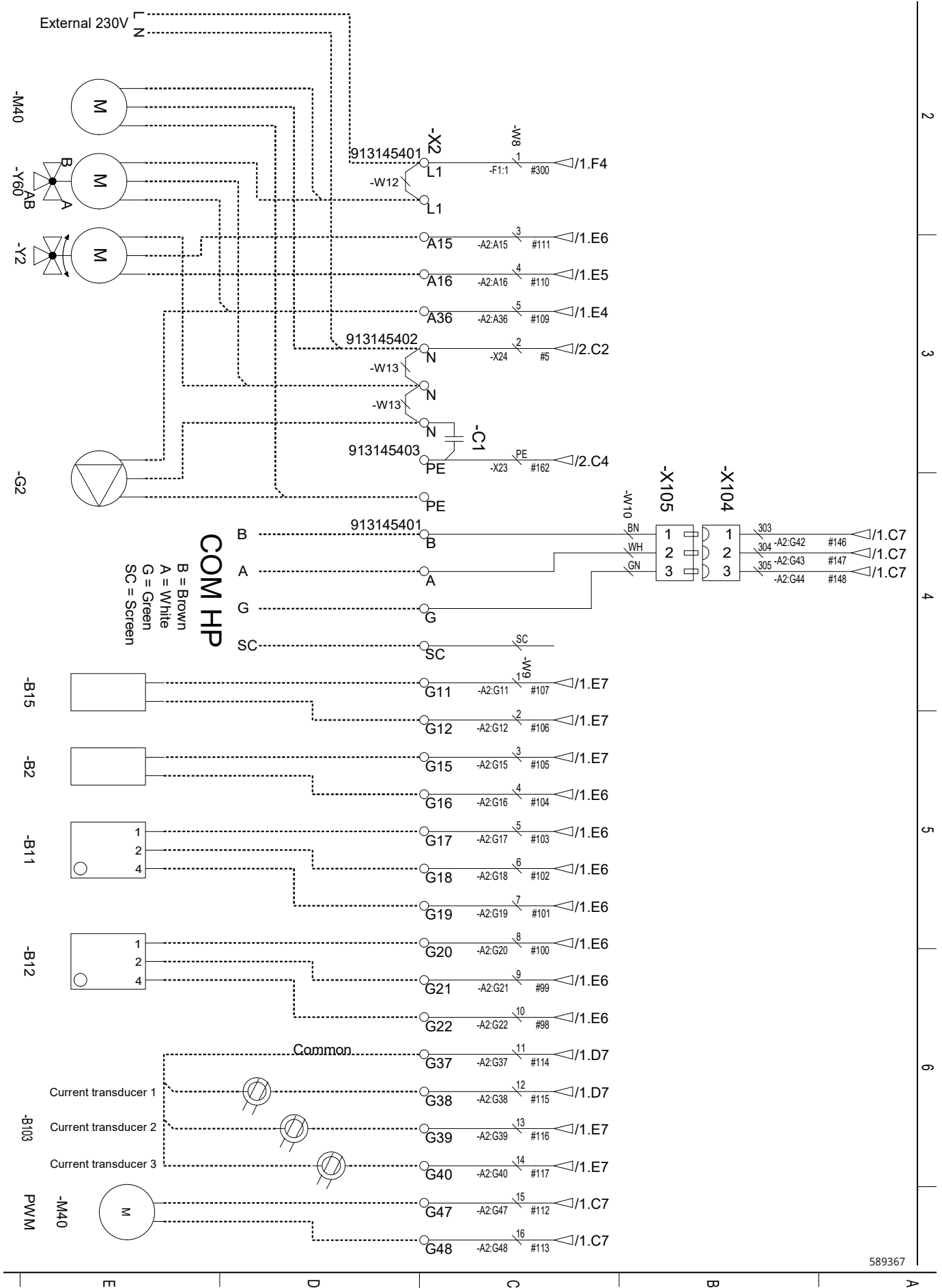

589367

### 13.19 Electrical diagram tank (A2), 3x230V /1.

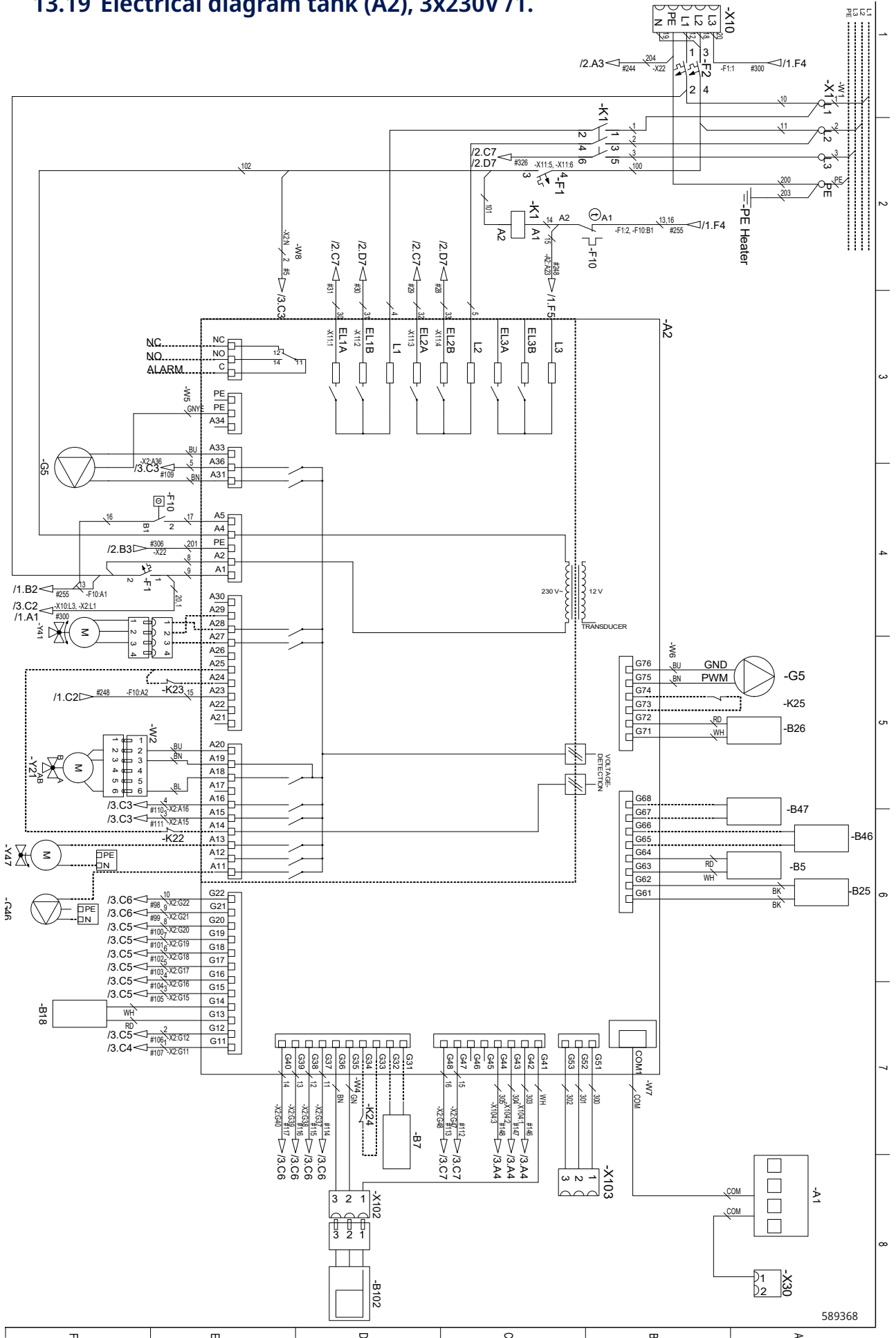

589368

### 13.20 Flow heater (E15), 3x230V /2.

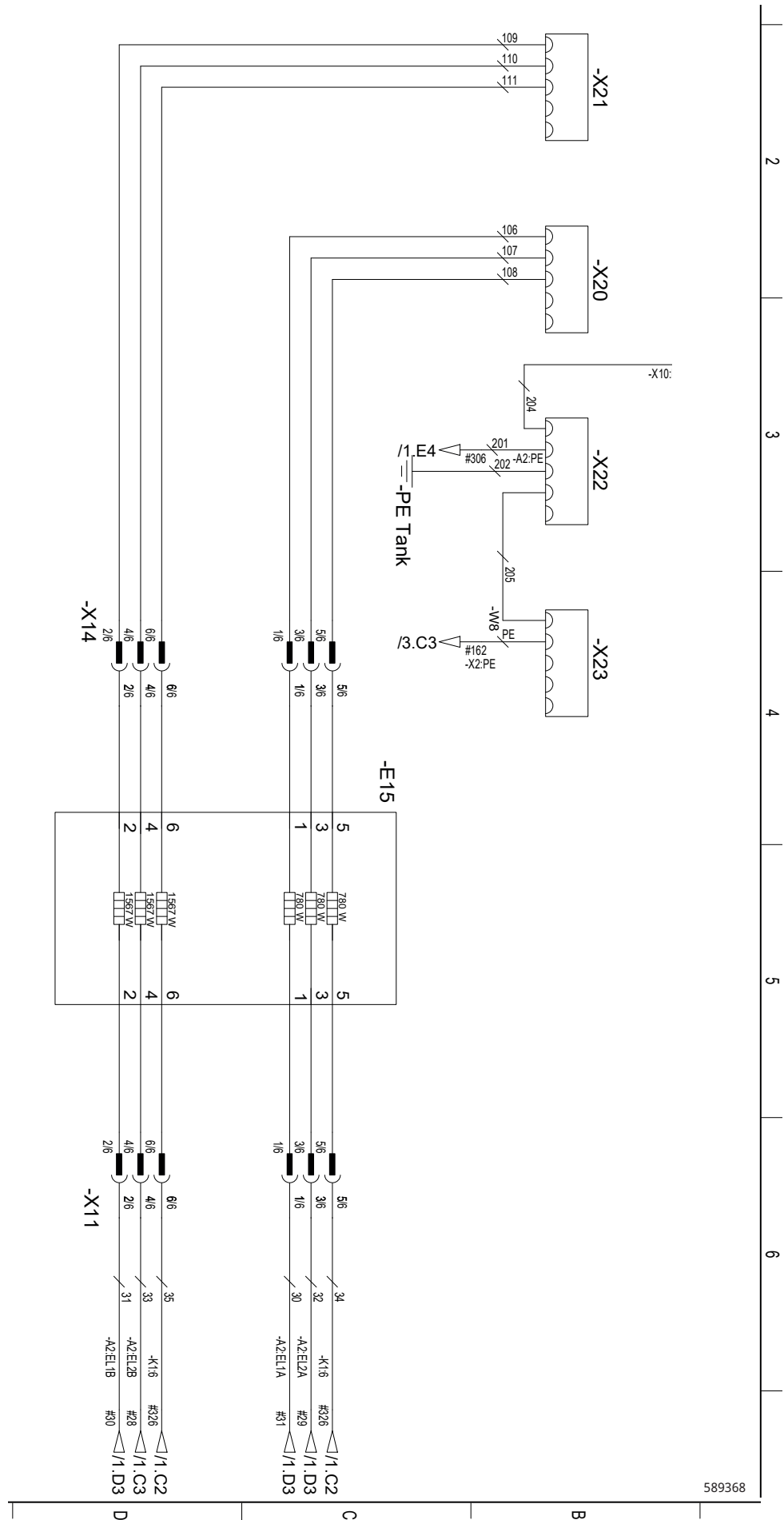

### 13.21 Terminal block (X2), 3x230V /3.

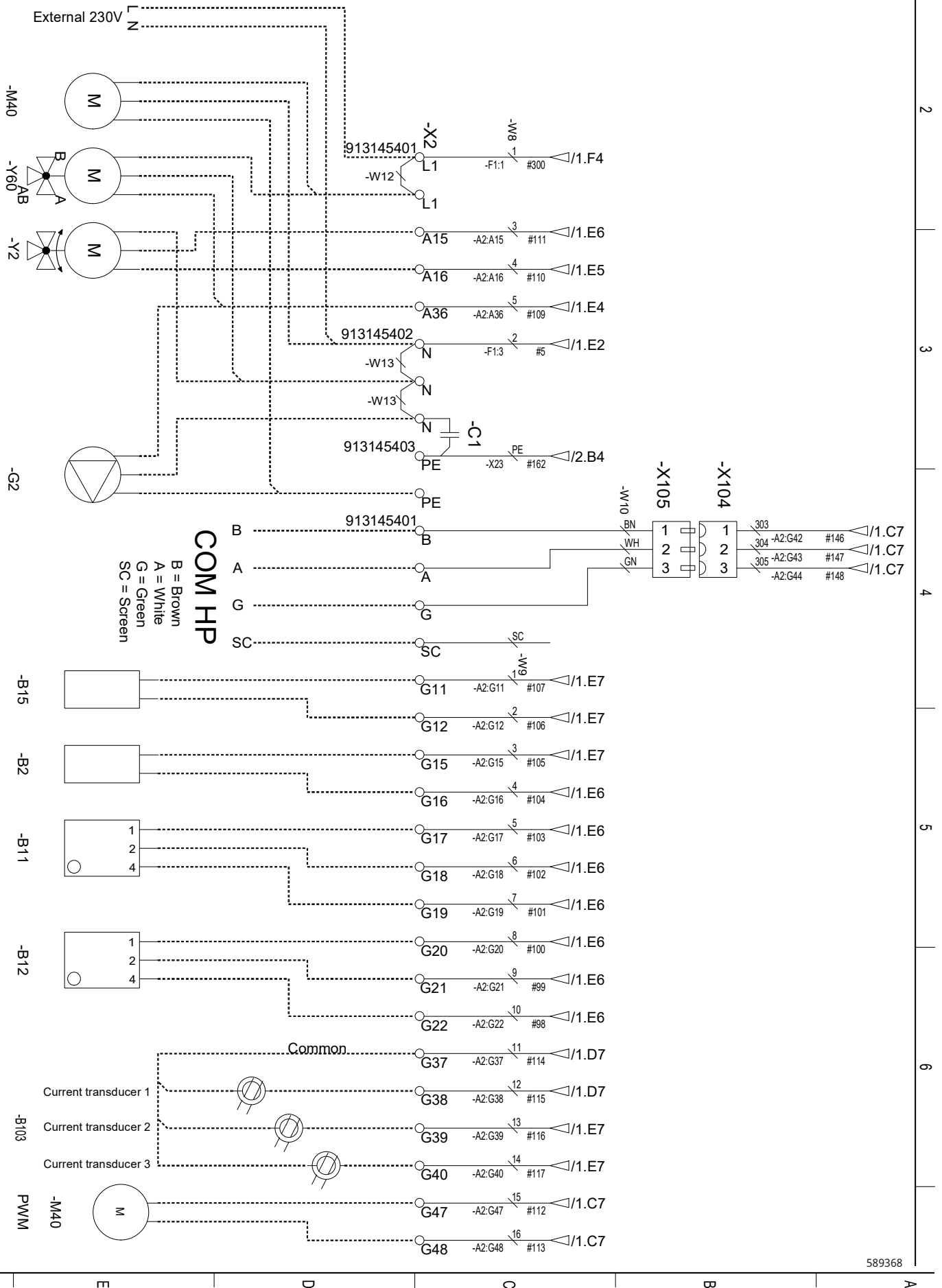

589368



# 13.22 HP cooling module schematic diagram 3x400V (A5)

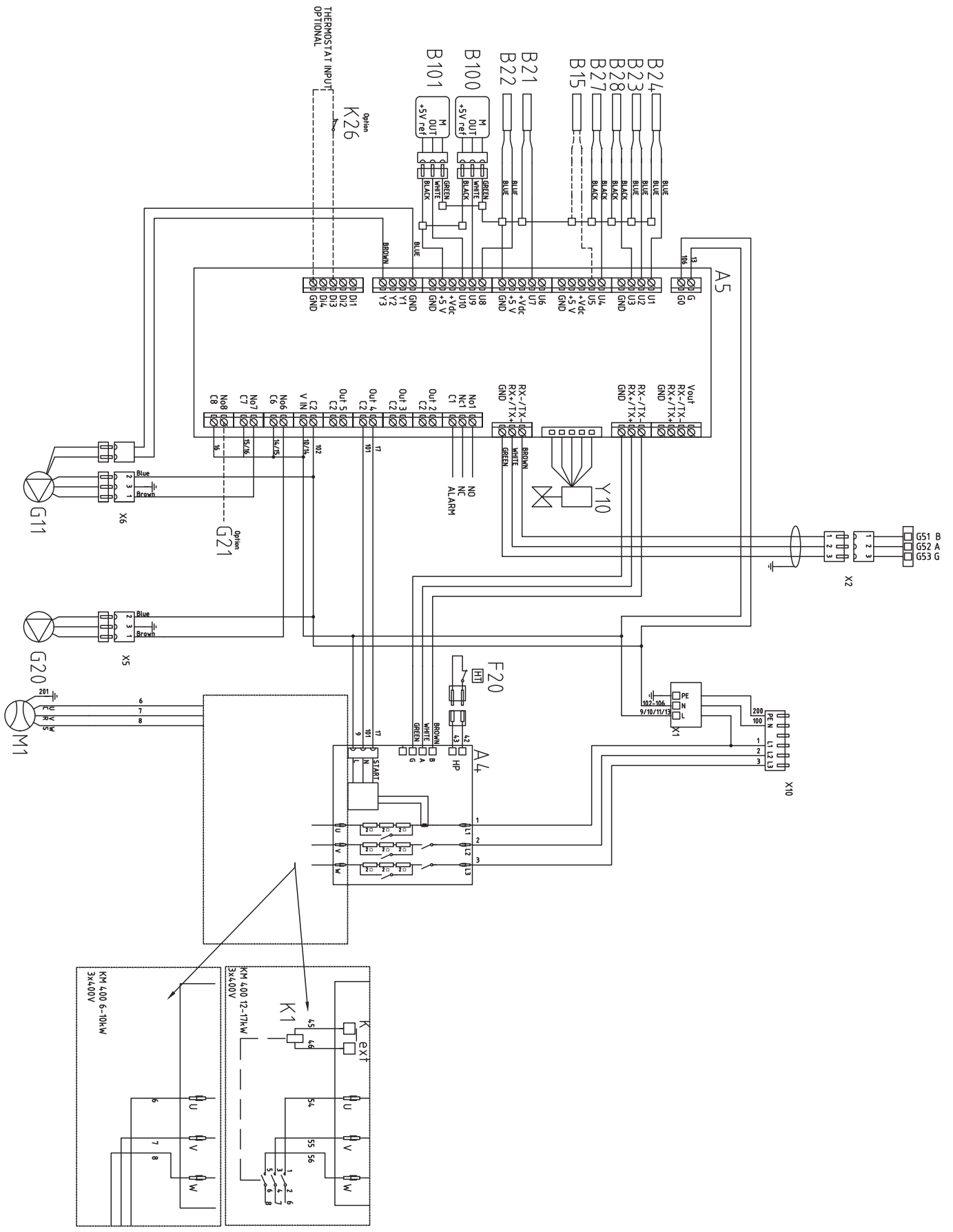

586833

1-79207291

### 13.23 HP cooling module schematic diagram 1x230V / 3x230V (A5)

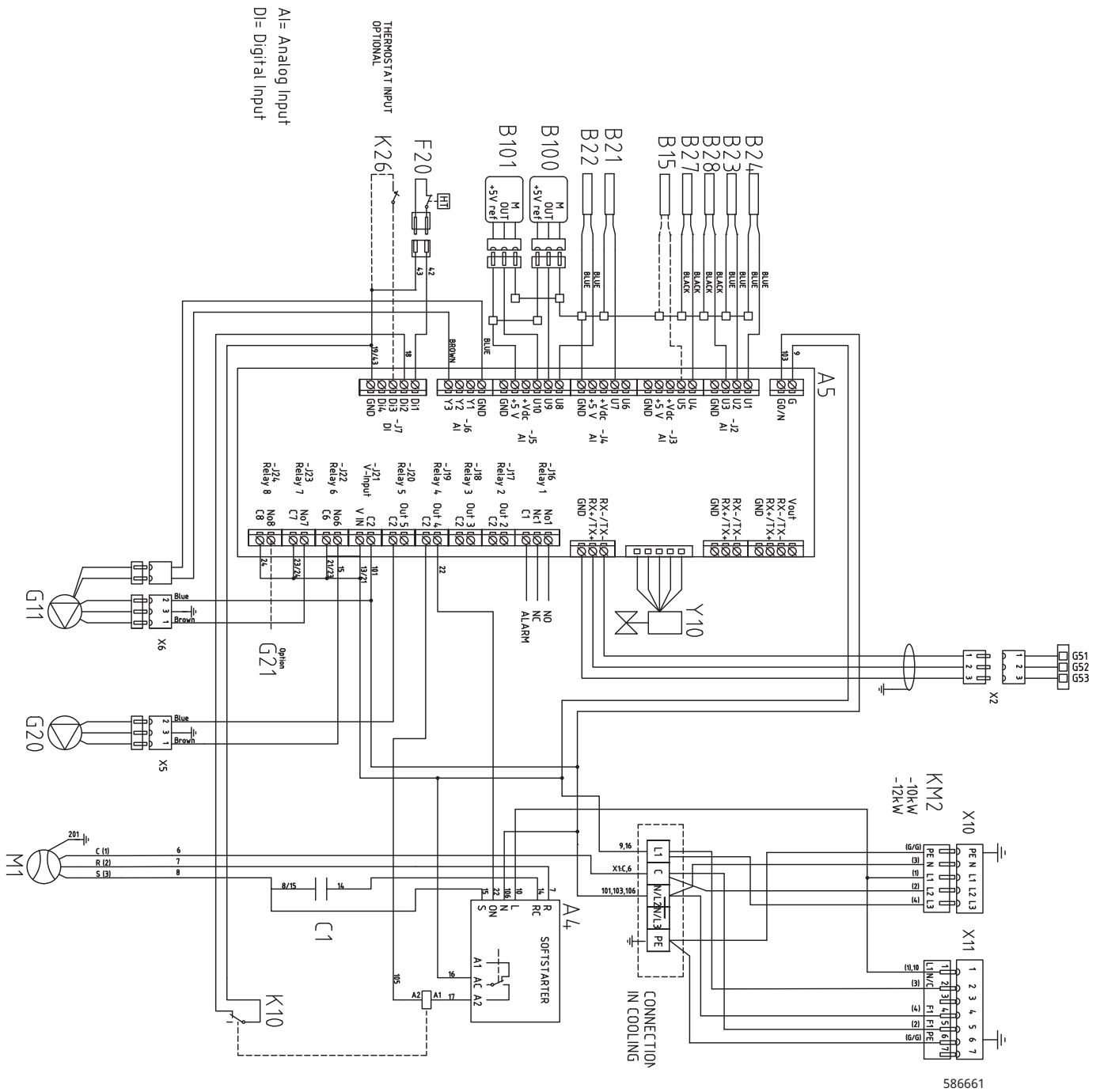

AI= Analog Input  
DI= Digital Input

586661

### 13.24 Expansion card (accessory) schematic diagram

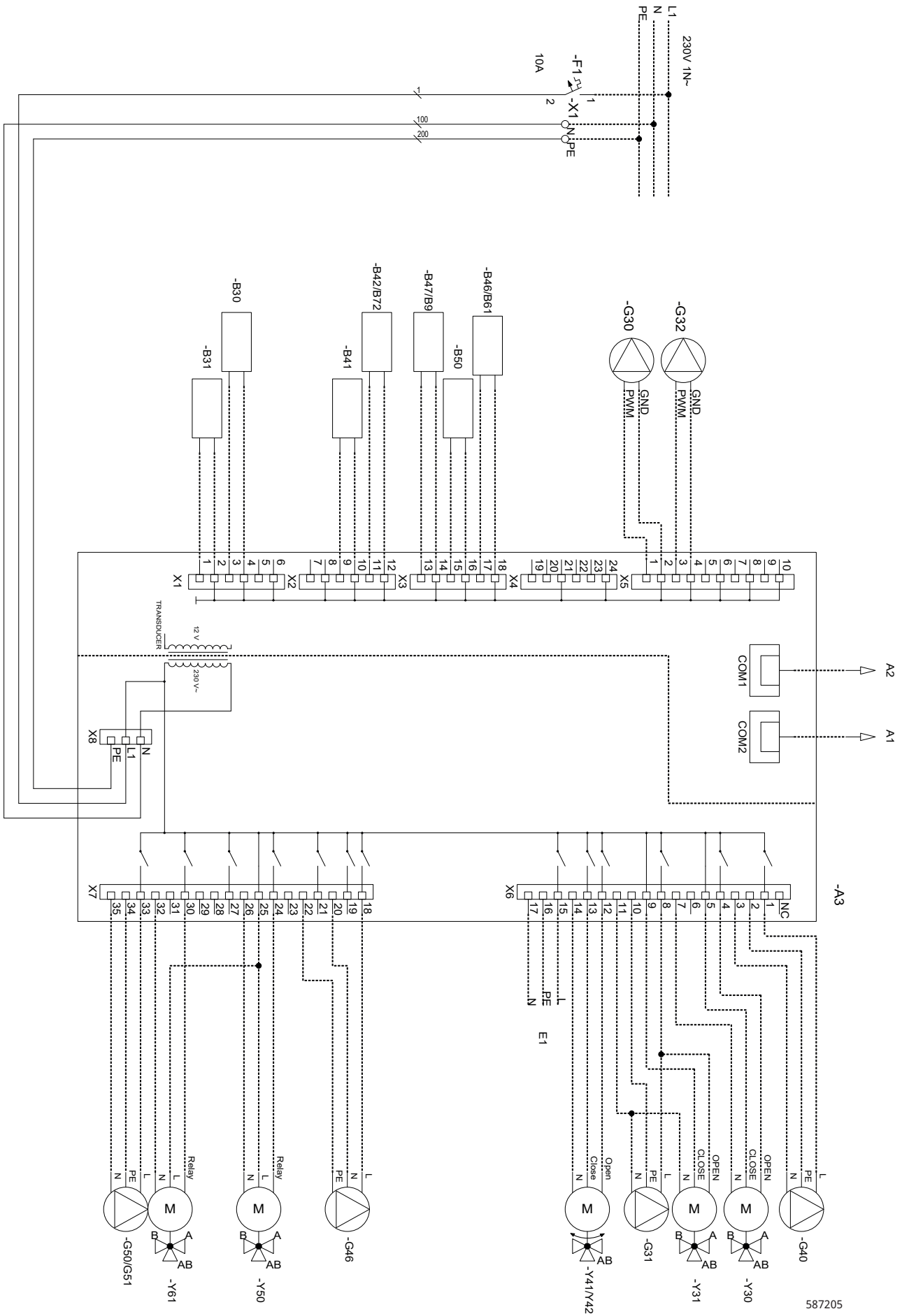

587205

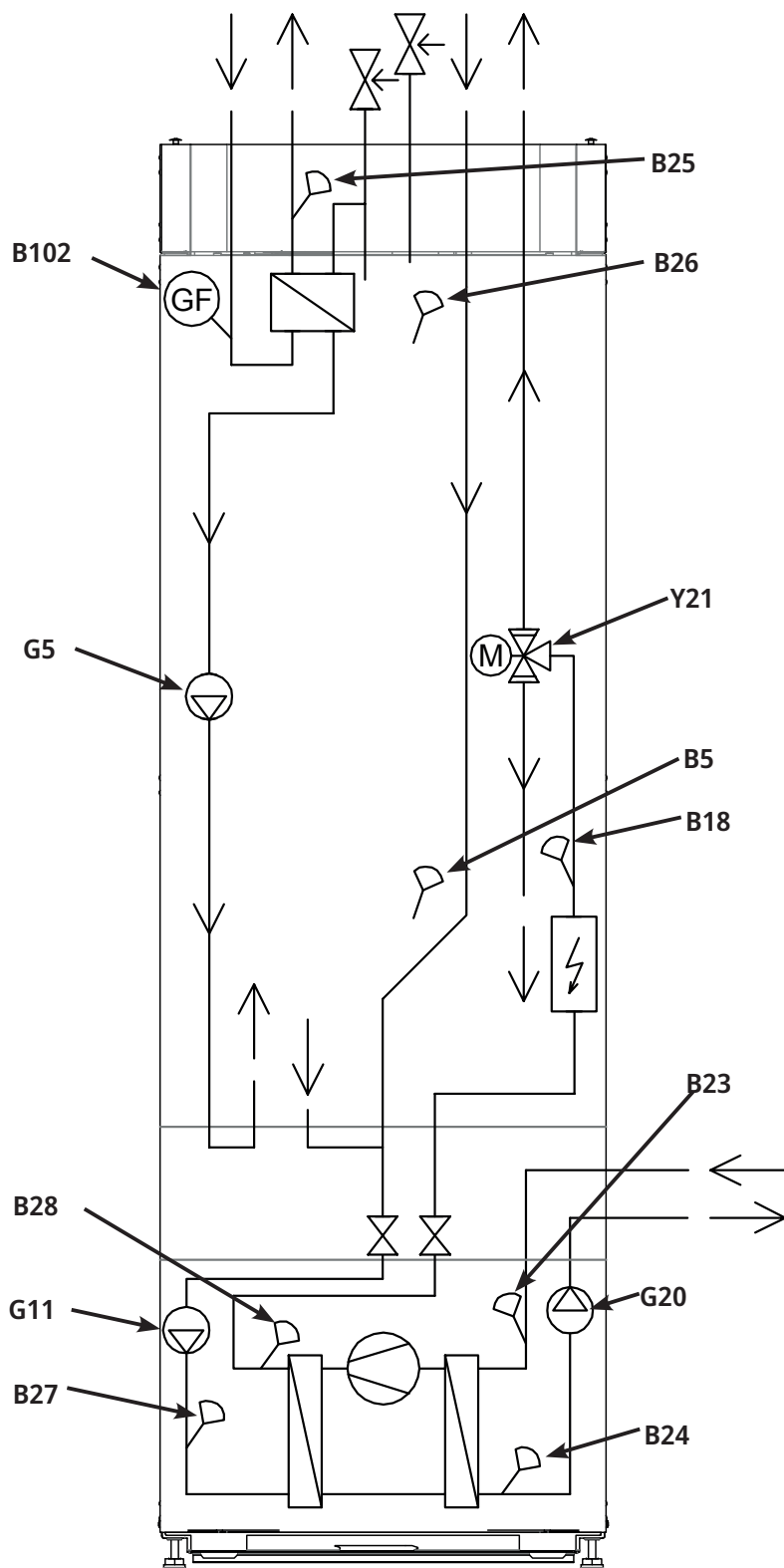

## 13.25 Component list

A1	Display	
A2	Relay/main card	
A3	Expansion card	
A6	Gateway, SmartControl	
A5	HP control card	
B2	Primary flow sensor 2	NTC 22
B5	Sensor, DHW tank	NTC 22
B7	Return sensor	NTC 22
B11	Room sensor 1	NTC 22
B12	Room sensor 2	NTC 22
B15	Outdoor sensor	Type 1/ NTC 150
B18	Primary flow sensor	NTC 22
B21	Temperature sensor Discharge	Type 3/ NTC 50
B22	Temperature sensor Suction gas	Type 1/ NTC 015
B23	Brine in	Type 1/ NTC 22
B24	Brine out	Type 1/ NTC 22
B25	DHW sensor	NTC 015
B26	Sensor, upper hot water tank	NTC 22
B27	HP in	Type 2/ NTC 22
B28	HP out	Type 2/ NTC 22
B30	Solar panel sensor In	PT 1000
B31	Solar panel sensor Out	PT 1000
B41	Sensor, external buffer tank upper	NTC 22
B42	Sensor, external buffer tank lower	NTC 22
B46	Sensor diff thermostat	NTC 22
B47	External heat source tank	NTC 22
B50	Sensor pool	NTC 22
B100	High pressure sensor	
B101	Low pressure sensor	
B102	Flow switch	
F1	Automatic circuit breaker	10 A
F2	Automatic circuit breaker	13 A
F10	Max thermostat	
F20	High pressure switch	

G2	Circulation pump 2	
G5	Circulation pump for DHW heat exchanger	
G11	Charge pump HP1	
G20	Brine pump	
G30	Circulation pump, solar panel	
G31	Pump, bore hole recharging	
G32	Pump, plate heat exchanger – solar energy	
G40	Circulation pump for DHW circ.	
G46	Circulation pump, diff thermostat	
G50	Circulation pump, pool	
K1	Contactors 1	
K22- K25	Flexible remote control/ SmartGrid	
K26	Thermostatic control, accessory (Basic Display)	
M1	Compressor	
M40	Fan	
X1	Terminal board	
X10	Extra terminal board	
Y2	Mixing valve 2	
Y10	Expansion valve	
Y21	3-way valve DHW 1	
Y30	Solar 2-step valve external buffer tank	
Y31	Solar 2-step valve	
Y41	External heat source tank	
Y47	Electric shut-off valve	
Y50	3-way valve, pool	
Y60	3-way valve, passive cooling	

## 13.26 Resistance values for sensor, cooling module

Temperature °C	Sensor Type 1 NTC Resistance kΩ	Temperature °C	Sensor Type 2 NTC Resistance kΩ	Temperature °C	Sensor Type 3 NTC Resistance kΩ	Temperature °C	NTC 015 Resistance kΩ
100	0.22	100	0.67	130	5.37	110	0.76
95	0.25	95	0.78	125	6.18	105	0.86
90	0.28	90	0.908	120	7.13	100	0.97
85	0.32	85	1.06	115	8.26	95	1.11
80	0.37	80	1.25	110	9.59	90	1.27
75	0.42	75	1.47	105	11.17	80	1.67
70	0.49	70	1.74	100	13.06	75	1.92
65	0.57	65	2.07	95	15.33	70	2.23
60	0.7	60	2.5	90	18.1	65	2.59
55	0.8	55	3.0	85	21.4	60	3.02
50	0.9	50	3.6	80	25.4	55	3.54
45	1.1	45	4.4	75	30.3	50	4.16
40	1.3	40	5.3	70	36.3	45	4.91
35	1.5	35	6.5	65	43.6	40	5.83
30	1.8	30	8.1	60	52.8	35	6.9
25	2.2	25	10	55	64.1	30	8.3
20	2.6	20	12.5	50	78.3	25	10.0
15	3.2	15	15.8	45	96.1	20	12.1
10	4	10	20	40	119	15	14.7
5	5	5	26	35	147	10	18
0	6	0	33	30	184	5	22
-5	7	-5	43	25	232	0	27
-10	9	-10	56	20	293	-5	34
-15	12	-15	74	15	373		
-20	15	-20	99	10	479		
-25	19	-25	134	5	619		
-30	25	-30	183				

### 13.27 Resistance values for sensor, other

Temperature °C	NTC 22 kΩ Resistance Ω
130	800
125	906
120	1027
115	1167
110	1330
105	1522
100	1746
95	2010
90	2320
85	2690
80	3130
75	3650
70	4280
65	5045
60	5960
55	7080
50	8450
45	10130
40	12200
35	14770
30	18000
25	22000
20	27100
15	33540
10	41800
5	52400
0	66200
-5	84750
-10	108000
-15	139000
-20	181000
-25	238000

Temperature °C	NTC 150 Resistance Ω
70	32
65	37
60	43
55	51
50	60
45	72
40	85
35	102
30	123
25	150
20	182
15	224
10	276
5	342
0	428
-5	538
-10	681
-15	868
-20	1115
-25	1443
-30	1883
-35	2478
-40	3289

# 14. Installation Communication

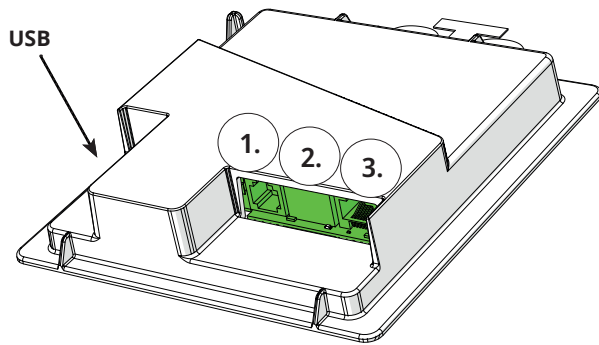

The back of the display unit has 3 communication ports.



Menu: "Installer/Define/Communication".



## Display communication ports

- 1 **Port 1. RS485 port without galvanic protection. For external equipment, e.g. property control (BMS\*).**

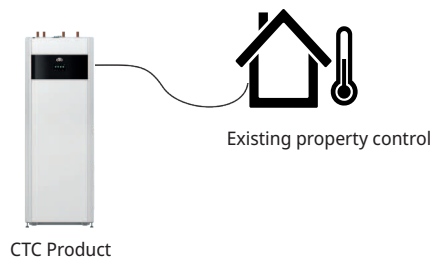

- 2 **Port 2. Network jack (ethernet), see connection information on following page.**  
Define the app:  
myUplink: "Yes" enables connection to the app.

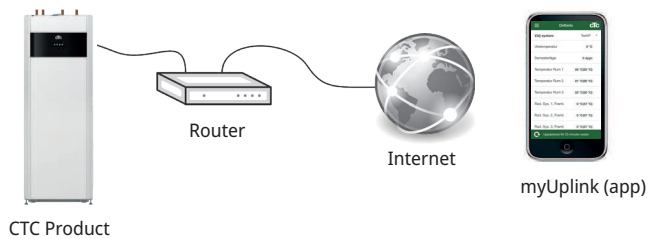

Define Web:

"Yes" permits network connection, the "CTC Remote" screen mirror feature and BMS\* function with remote control via network cable to local network.

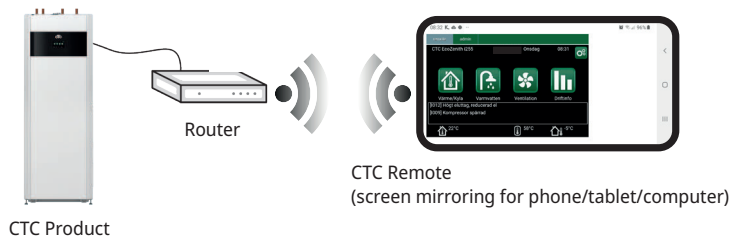

- 3 **Port 3. Communication between the product's electrical cabling and display: Factory fitted.**

\*Port 2 - Network socket (Ethernet) when connecting the BMS via TCP/IP.



## 14.1 Install ethernet cable

In order to define and enable connection to the network and app, an ethernet cable must be connected as described below.

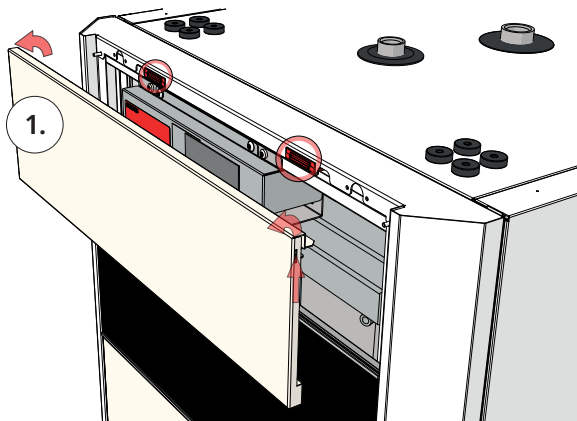

1. Pull out the magnetic strip. It is secured with magnets. If difficult to remove, use a small screwdriver in the notch along the top edge.

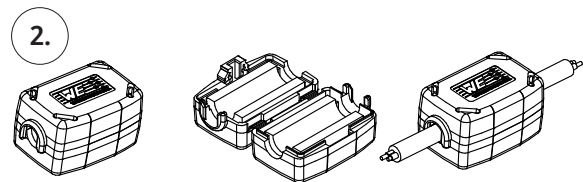

2. Open the ferrite from the packaging, clamp around the ethernet cable with the connector.

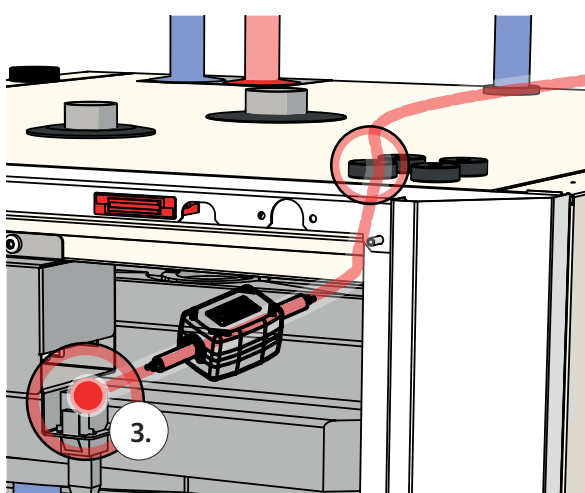

3. Connect the ethernet cable.

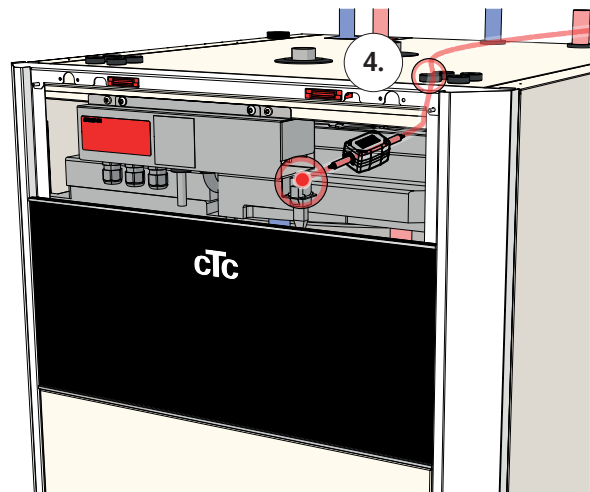

4. Route the ethernet cable through any hole in the top cover, remove rubber grommet if necessary.

5. Connect ethernet cable to network port or router.

To permit and define connectivity, refer to the "Communication" section in the "Installer/Define" chapter.



## 14.2 Remote - Screen Mirroring

- Connect the ethernet cable, see previous page.
- Installer/Define/Communication/Web – Yes. Permits the product to connect with unencrypted web traffic on local area networks. Internet router and firewall required.
- Installer/i – Scan the QR code with a tablet or smartphone. 
- Save as favourite/icon on phone/tablet/computer. When your phone/tablet is connected to your local network, the product can be used with your device's touchscreen in the same way as the product's screen.
- In the app: scan QR code or enter address "http://ctcXXXX/main.htm". (XXXX = the last four digits of the display serial number, for example S/N 888800000040 = "http://ctc0040/main.htm"). In case of problems: click the link to update to the device's current IP no.

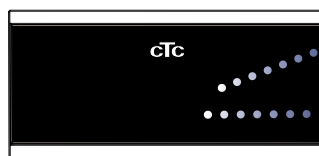

Tablet/Smartphone/PC as a touchscreen for local area network "Installer/Define/Communication/Web" – "Yes".



## 14.3 myUplink - App

Define myUplink. See "Installer/Define/Communication/myUplink – Yes".

Installing the app.

- Download myUplink from the AppStore or Google Play.
- Create an account.
- Follow the instructions in the app's Help feature.

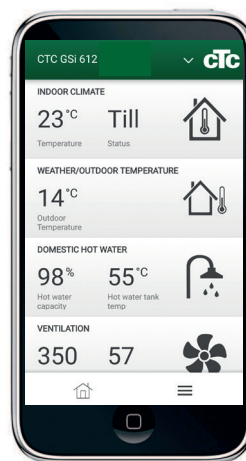

## 15. First start

When the heat pump is delivered, the compressor is blocked to avoid it being unintentionally started. The heat pump can be installed and started before the brine circuit is put into operation.

The heat pump can also be started without a fitted room sensor. The set curve will then regulate the heating. The sensor can, however, always be fitted for the alarm LED function.

### Before first start

1. Check that the heating boiler and system are full of water and have been bled.
2. Ensure that the brine system is filled with water and antifreeze and that it is bled or ensure that the compressor is blocked.
3. Check that all connections are tight.
4. Check that all sensors are connected to the electrical supply.
5. Check that the connections behind the insulation caps are secure. Remove both insulation caps by pulling carefully on the points marked.
6. The backup heating thermostat is OFF as its factory setting. Recommended mode is ❄️ = Frost protection setting, approx. +7 °C. The backup heating thermostat is in the electrical switchboard behind the front panel. It is in the OFF position when it is turned anticlockwise as far as it will go (the screwdriver slot should be vertical).

**At the end of the installation, check the connections of any current sensors. In this situation it is important that you have switched off any major consumers of electricity in the house. Also make sure that the backup thermostat is turned off.**

**NB: The product has an automatic bleeding sequence for the DHW system, which runs in the background. The sequence takes approx. 15 minutes and does not affect other functions.**

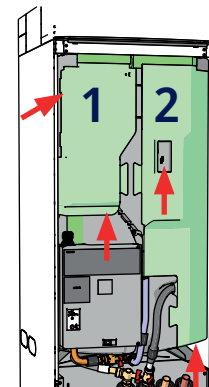

Check connections.



Symbol for backup heating thermostat:

## First start

Switch on the power using the safety switch. The display will switch on. The heat pump now asks the following:

1. Select the language and push OK.
2. Confirm that the system is filled with water and press OK.
3. Size of main fuse. Choose between 10 and 35 A.
4. Specify the maximum immersion heater power. Choose between 0.0 and 9.0 kW in steps of 0.3 kW. Also see "When only an electric boiler is operating" below.
5. Select the option permitting the compressor to operate (if the collector system is ready).  
When the compressor is started for the first time, a check is automatically carried out to ensure that it is running in the correct direction.
6. Brine pump on 10 days.
7. Specify the max primary flow °C for heating circuit 1.
8. Specify the inclination for heating circuit 1.
9. Specify the adjustment for heating circuit 1.  
If the primary flow sensor for heating circuit 2 is installed, repeat steps 7 to 9 for heating circuit 2.
10. The heat pump then starts and the start menu appears.

### When only an electric boiler is operating.

When starting the product without a borehole, it is necessary to specify the electrical power for hot water production in the menu "Installer/Settings/Immersion heater/Max immersion heater DHW kW".

● The selected power output must be written on the rating plate with a marker.

● Save these settings in the "Installer/Settings/Save my Settings" menu.

## 16. Operation and Maintenance

When the installer has installed your new heat pump, you should check along with the installer that the system is in perfect operating condition. Let the installer show you where the switches, controls and fuses are so that you know how the system works and how it should be maintained. Bleed the radiators after around three days of operation and top up with water if required.

### Boiler and heating circuit bleeding/safety valve

Check around four times a year that the valve is working correctly by manually turning the control. Check that there is water and not air coming out of the waste pipe; if air is coming out then the tank will need to be bled.

### Mixing valve (accessory)

Mixing valve (Y2) is operated automatically from the control system, ensuring that the radiators reach the correct temperature, no matter what season it is. However, where a fault occurs, you can operate the valve by pulling out the knob on the motor and turning it clockwise to reduce the temperature or anticlockwise to increase it.

### Draining the tank

The heat pump should be disconnected from the power source when it is being drained. The drainage valve is positioned at the bottom left of the unit when viewed from the front, behind the front of the heat pump. When draining the whole system, the mixing valve should be fully open, i.e. turned anticlockwise as far as it will go. Air must be supplied to the closed system.

### Operation stop

The heat pump is shut down using the operating switch. If there is a risk of the water freezing, all the water should be drained from the heat pump and the heating circuit. The DHW circuit, which contains around five litres, is emptied by inserting a hose at the bottom of the cold water connection and then siphoning it off.



**i** Do not forget to reset the mixing valve (Y2) to automatic mode.

## 17. Detailed menu descriptions

All settings can be configured directly on screen using the straightforward control unit. The large icons function as buttons on the touch display. Operational and temperature information is also displayed here. You can easily access the different menus to find information on the operation or to set individual values.

Submenus that do not fit on the display can be accessed by pressing the down arrow on the display screen or by scrolling down by hand. A white scrollable list shows you where you are.

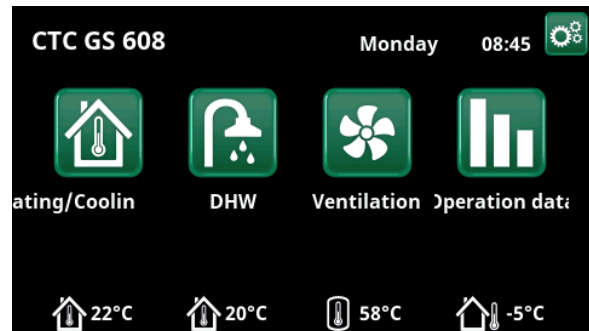

Start menu, model CTC GS 608.

### 17.1 Start menu

This menu is the system's home screen. An overview of the current operational data is provided here. All other menus can be accessed from this menu. Depending on which system is defined, the following symbols may appear on the start menu, for example:



#### Heating/Cooling

Settings for raising or lowering the temperature indoors and for scheduling temperature changes. Submenus for "Cooling" are shown if defined.



#### DHW

Settings for DHW production.



#### Ventilation

Settings for ventilation mode if the system includes a separate ventilation unit.



#### Operation data

This shows current and historical operational data for the system.



#### Installer

This is where the installer configures the settings and service for your system.



#### Indoor temperature

Displays the current indoor temperature for each heating circuit if room sensors have been installed.



#### DHW temperature

Shows the current temperature in the upper tank.



#### Outside Temperature

Shows the outdoor temperature.

## 17.2 Installation wizard

When starting up the system and during reinstallation (refer to the "Installer /Service" chapter), a number of system options must be selected. The dialogue boxes which will then be displayed are described below. The values shown in the menu screenshots below are only examples.

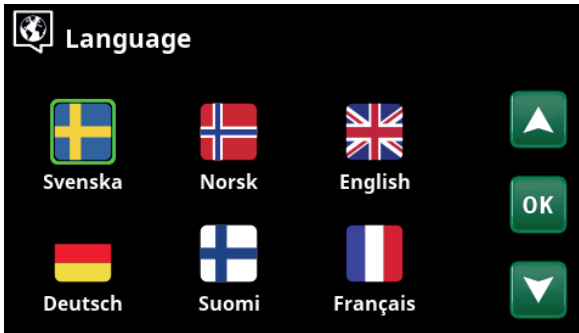

1. Choose language. Press OK to confirm.



2. Select the country where the installation is located. Confirm with "OK".

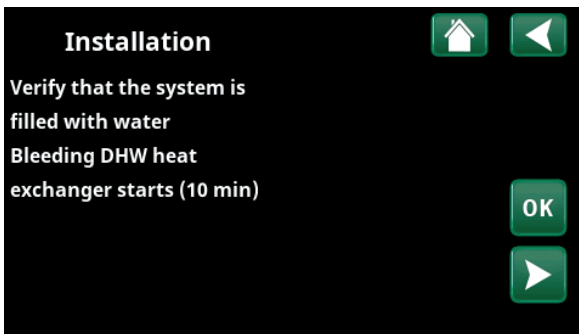

3. Verify that the system is filled with water. Confirm with "OK" and the "right" directional arrow.



4. Select the size of the main fuse using the "+" and "-" buttons. Confirm with the "right" directional arrow. For more information about settings, refer to the "Installer/Settings/Immersion heater" chapter.

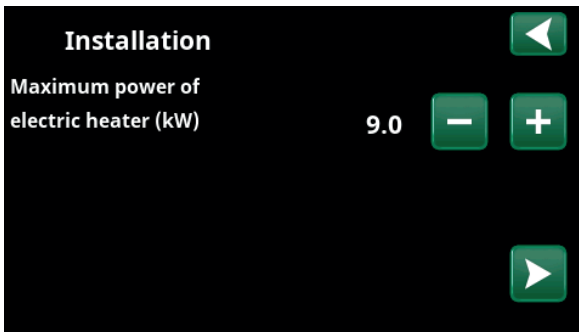

5. Select maximum immersion heater power using the "+" and "-" buttons. Confirm with the "right" directional arrow. For more information about settings, refer to the "Installer/Settings/Immersion heater" chapter.

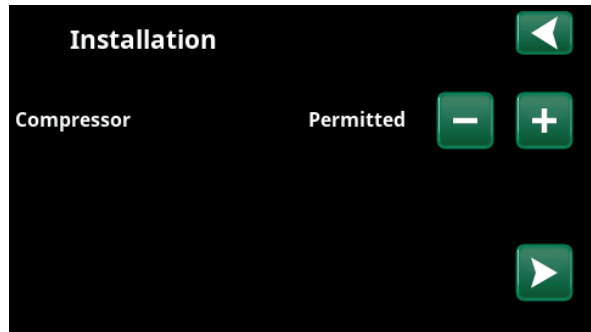

6. Specify whether the compressor is "Permitted" or "Blocked" using the "+" and "-" buttons. Confirm with the "right" directional arrow.

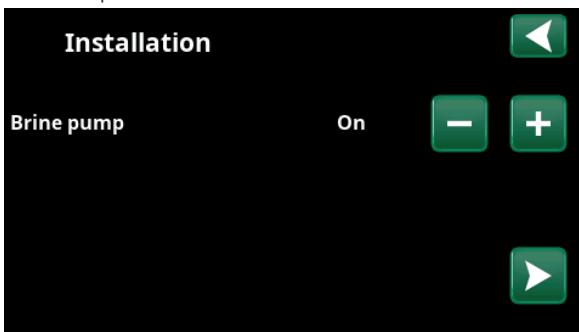

7. Specify whether the brine pump is "On", "10d" or "Auto" using the "+" and "-" buttons. Confirm with the "right" directional arrow. For more information about settings, refer to the "Installer/Settings/Heat Pump" chapter.

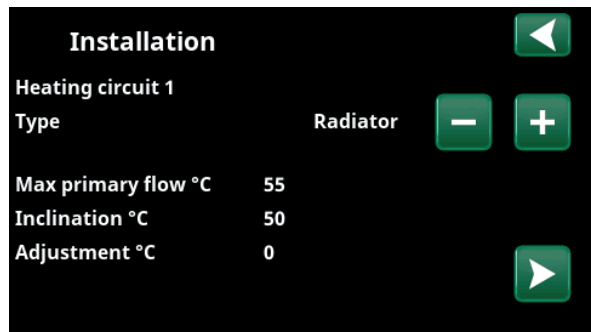

8. Specify whether heating circuit 1 applies to radiators or underfloor heating. Switch between "Radiator" and "Underfloor Heating" using the "+" and "-" buttons. Confirm with the "right" directional arrow.

9. If Heating circuit 2 is defined, the corresponding menu for this system is displayed. Make a corresponding selection ("Radiator" and "Underfloor Heating") for Heating circuit 2 and finish the wizard with "OK".



## 17.3 Heating/Cooling

In the menu "HC- Heating/Cooling" the following settings can be made:

### 17.3.1 Setpoint setting with room sensor

Set the desired room temperature (set point) with the "minus" and "plus" buttons. In the example in the "HC1 Heating/Cooling" menu, the "Economy" programme and "Holiday mode" (V) are active for heating circuit 1.

In the "HC2 Heating/Cooling" menu, the "Cooling" mode is active.

"Holiday mode" and "Night reduction" only lower the room temperature when heating mode is active.

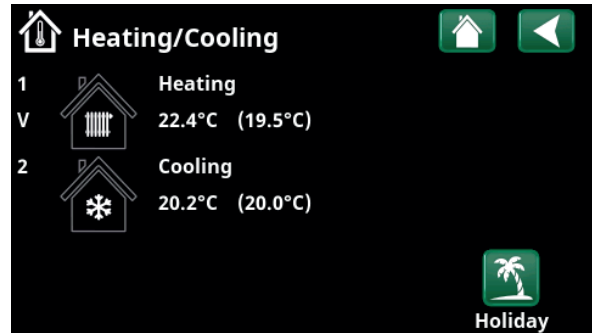

Click on heating circuit 1 or 2 to go to the menu of the respective heating circuit. In this menu you can activate "Holiday mode" for the heating circuits.

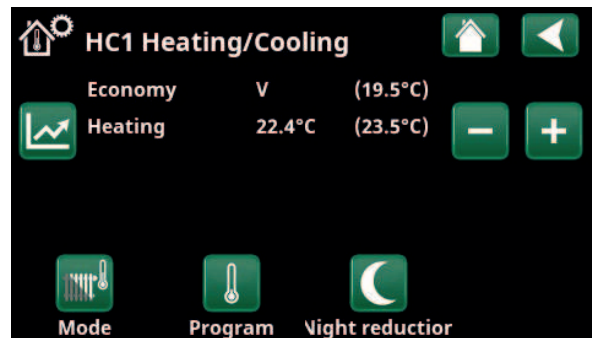

In the menu, programs "Economy" and "Holiday mode" (V) are active for heating circuit 1. In this example, both the "Economy" and "Holiday Mode" programmes are set to lower the set point (23.5 °C) by 2 °C, which means that the actual set point = 23.5 - 2 - 2 °C = 19.5 °C.

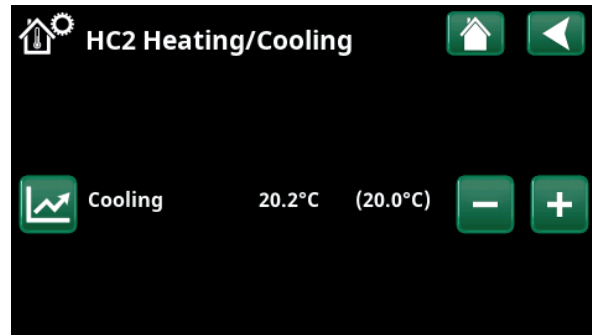

In the menu, "Cooling" (setpoint: 20.0 °C) is active for heating circuit 2. "Holiday mode" (V) does not lower the setpoint when cooling is active.





### 17.3.2 Program

Press the "Program" button and the heating program to be activated (Economy, Normal, Comfort or Custom). It is also possible to schedule the programmes.

See chapter "Installer/Settings/Heating circuit/Program" for information on how to set temperature increases/decreases and delay times for the programmes.



### 17.3.3 Heating curve

Press the heating curve symbol in the "HC1- Heating/Cooling" menu. The graph of the heating circuit heat curve is displayed.

The chapter "Installer/Installation/Heating circuit" describes the setting of the heating curve.

See also chapter "House heating curve" for more information on adjusting the heating curve.



### 17.3.4 Heating mode

Press the "Mode" button and then select "Heating mode"; "Auto", "On" or "Off".

Heating mode can also be selected in the menu "Installer/Settings/Heating circuit/Heating mode".

See chapter "Installer/Settings/Heating circuit" for more information.

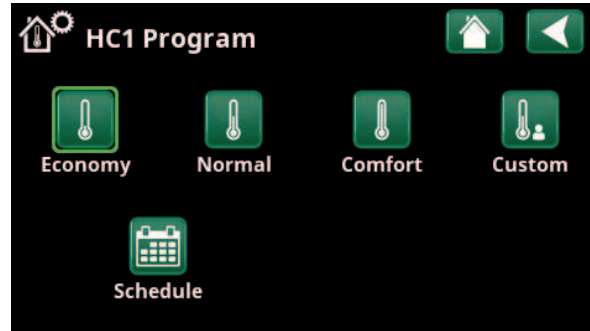

Menu "HC1 Heating/Cooling / HC1 Program" where program "Economy" has been activated.

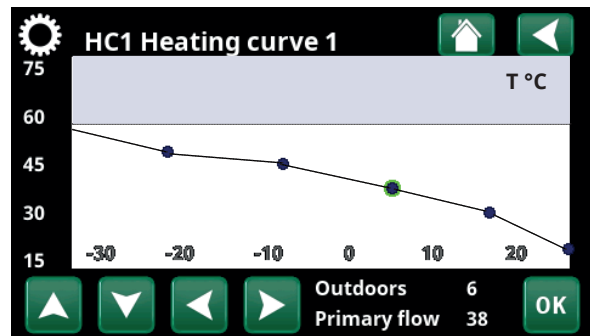

Menu "Heating/Cooling/HC1 Heating/Cooling".

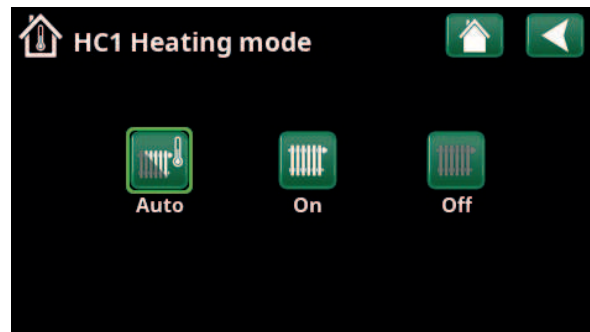

Menu "HC1 Heating/Cooling/HC1 Heating mode" where mode "Auto" has been activated.

### 17.3.5 Room temperature setting without room sensor

You can select "Room sensor - No" in the "Installer/Define/Heating circuit" menu. This is used if the room sensor is difficult to place, if the underfloor heating system control has its own room sensor or if you are using a wood-burning stove/fireplace. The alarm LED on the room sensor works as usual.

If a wood-burning stove or fireplace is used sporadically, the burning may cause the room sensor to reduce the temperature of the heating circuit and it may become cold in the rooms in other parts of the house. The room sensor can then be temporarily switched off during firing and the heat pump provides heat to the heating circuit according to the set heating curve. The radiator thermostats are throttled in the part of the house where the fire is burning.

If the room sensor has not been installed, the heating must be set according to the chapter "House heating setting".

### 17.3.6 Outdoor sensor/room sensor errors

If a fault occurs with an outdoor sensor, the product triggers an alarm and an outdoor temperature of -5 °C is simulated so that the house does not get cold.

If a fault occurs with a room sensor, the product triggers an alarm and automatically switches to operating according to the set curve.

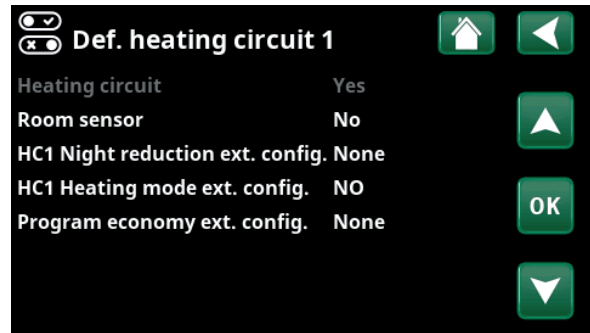

Menu "Installer/Define/Heating circuit/Heating circuit 1".

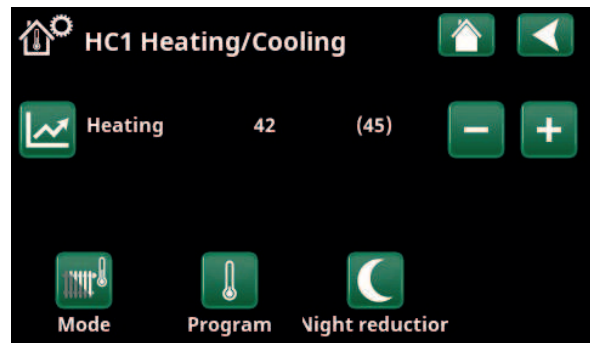

Menu "Installer/Define/Heating circuit/Heating circuit 1". The heating circuit has no room sensors. The setpoint (primary flow temperature 45 °C) is shown in brackets, the current primary flow temperature 42 °C is shown to the left of the setpoint.



### 17.3.7 Night Reduction Temperature

Night reduction means reducing the temperature indoors, via remote control or during scheduled periods.

In the menu "HC1 Night reduction" menu, the periods during the week for night temperature reduction can be scheduled.

The "Night reduction" icon in the "Heating/Cooling" menu only appears if a "Schedule" has been defined for the heating circuit in the "Installer/Define/Remote control" menu.

The "Schedule" chapter describes how to set schedules.

The value by which the temperature is reduced during remote control of the night reduction is set in one of the following menus.

**Room sensor installed:**

"Installer/Settings/Heating circuit/Room temp reduced night red °C".

**Room sensor not installed:**

"Installer/Settings/Heating circuit/Prim. flow reduced night red °C".

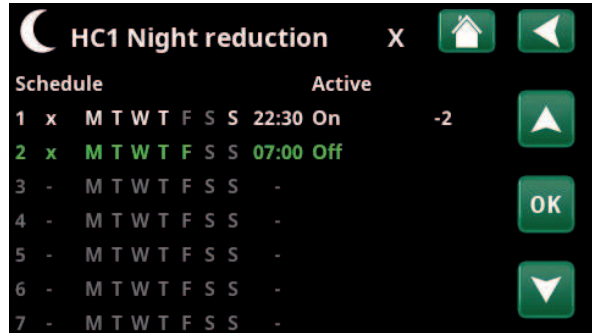

The schedule has been set for "Night Reduction" to be active weekdays between 22:30 and 07:00, except during the night between Friday and Saturday and the night between Saturday and Sunday (when no night reduction occurs).

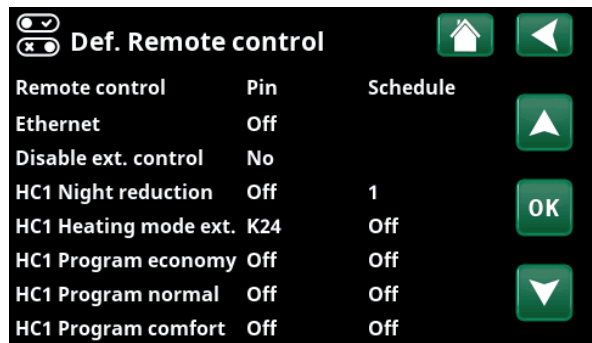

Menu: "Installer/Define/Remote Control".  
The "HC1 Night Reduction" function is assigned to Schedule #1.



### 17.3.8 Holiday

This option is used to set the number of days that you want continuous reduction of inside temperature, for example if you want to go on holiday.

The value by which the temperature is reduced during the period is set in one of the following menus:.

**Room sensor installed:**

"Installer/Settings/Heating circuit/Room temp reduced holiday °C".

**Room sensor not installed:**

"Installer/Settings/Heating circuit/Prim. flow reduced holiday °C".

Holiday reduction is enabled from the time of setting (press the plus (+) sign).

Up to 300 days can be set.

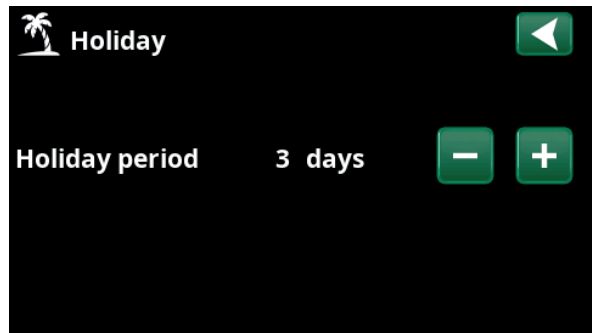

When holiday is enabled, hot water production is stopped. The "Temporary extra DHW" feature is also stopped.

When both "Night Reduction" and "Holiday Reduction" are in use, "Holiday Reduction" supersedes "Night Reduction".



## 17.4 DHW

This menu is used to set the hot water comfort level and "Extra DHW".

### Extra DHW

The "Extra DHW" function can be activated here. When the function is activated (by setting the number of hours using the plus sign in the "Hot Water" menu), the heat pump immediately starts to produce extra DHW. It is also possible to remotely control or schedule hot water production according to specified times.

### DHW mode

You set the values for this option which apply to the heat pump's normal operation. There are three modes:



#### Economy

For low hot water needs.  
(Factory value stop temperature DHW tank: 50 °C).



#### Normal

Normal hot water needs.  
(Factory value stop temperature DHW tank: 55 °C).



#### Comfort

For high hot water needs.  
(Factory value stop temperature DHW tank: 58 °C).

### 17.4.1 Extra DHW

You can use this menu to schedule periods during weekdays when you want extra DHW. This schedule is repeated every week.

The stop temperature for Extra DHW is 60 °C (factory setting).

The "Schedule" chapter describes how to set schedules.

Click the "Extra DHW" heading to obtain a graphical overview of when the schedule is active during weekdays.

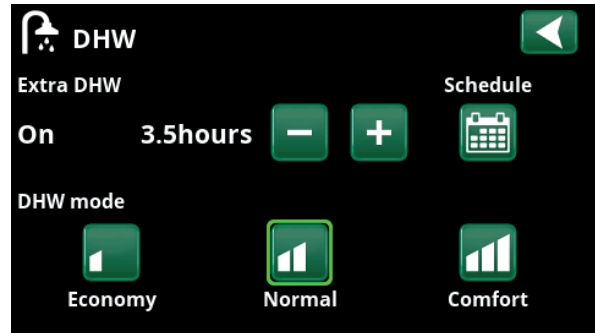

The "Extra DHW" function is set to be active for 3.5 hours.

**i** NB: Set the time approx. 1 hour earlier than when you need the hot water as it may take some time to heat-up.

**i** Tip: Set to "Economy" mode from the start. If the hot water is deemed insufficient, raise to "Normal" mode, and so on.

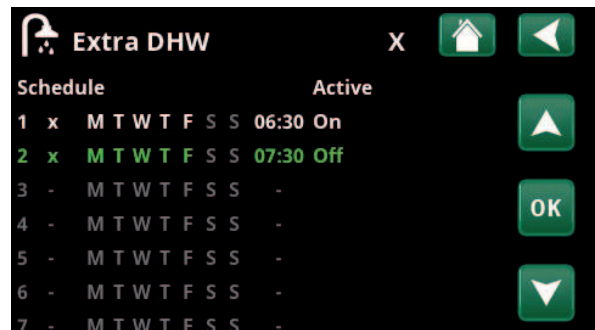

The "Extra DHW" function is set to be active on weekdays between 06:30 and 07:30.

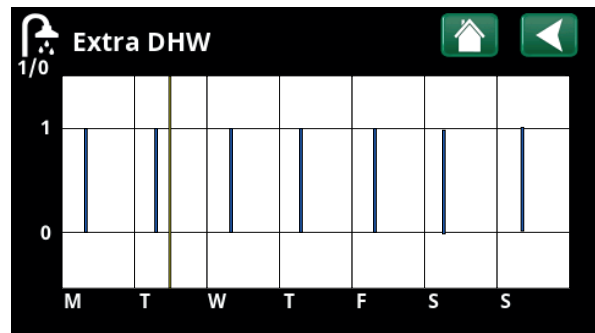

Use the Back button to switch between settings and preview. A vertical blue bar indicates when "Extra DHW" is active. A horizontal yellow line indicates the current time. The X axis represents the days, Monday to Sunday.



## 17.5 Ventilation

Refer to the "Installation and Maintenance Manual" for the CTC EcoVent ventilation product.

## 17.6 Schedule

In a Schedule, the periods can be set for when a function should be active or inactive during the weekdays.

The system does not allow certain functions to be active at the same time on the same schedule; for example, the "Night Reduction" and "Extra DHW" functions, but most functions can share the same schedule.

If several functions share the same schedule, changes to the schedule for one function will cause the same changes for the other functions that share the schedule.

To the right of the schedule header, an "X" will appear if the same schedule is also shared by another remote control function.

Click on the schedule's header row to see a graphical overview of when the schedule is active during the days of the week.

### 17.6.1 Defining a schedule

In this example, a night temperature reduction of heating circuit 1 (HC1) is programmed.

First, a schedule must be defined in the "Installer/Define/Remote control" menu.

Enter a schedule (1-20) in the "Schedule" column in the "HC1 Night Reduction" row using the arrow keys, or click where the cursor is in the example.

### 17.6.2 Schedule settings

A schedule can be set for most remotely controlled functions in the menus under "Installer/Settings".

However, schedules for "Night reduction", "Extra DHW" and "Ventilation" can only be accessed via the start menu.

The schedule includes 30 rows and a setting can be made in each row. For example, in one row you can set the date and time for the function to activate, and the time the function should deactivate in the row below.

In the example, "Night reduction" for heating circuit 1 has been set to be "On" from 22:30 to 07:00 on weekdays, except for weekends (Friday and Saturday nights).

The second row is highlighted green, which means that row is active at the current time.

**Schedule** **Active**  
(Active/Inactive/Restore factory settings)

Activate the schedule by setting it to "Active" mode. It is also possible to restore factory settings.

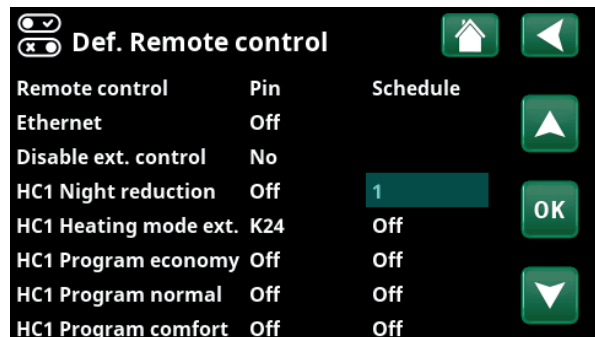

Menu: "Installer / Define / Remote Control".

The "HC1 Night Reduction" function is assigned to Schedule #1.



Click on the "Night Reduction" icon in the heating circuit "Heating/Cooling" menu to set the schedule.

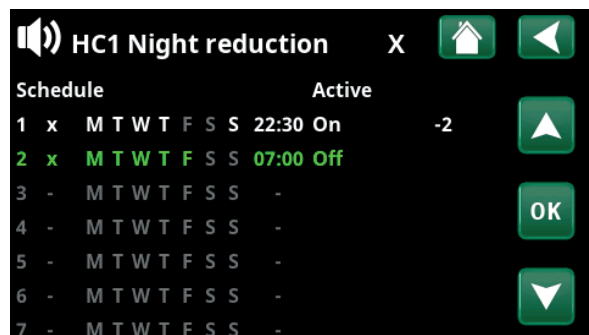

The schedule has been set for "Night Reduction" to be active weekdays between 22:30 and 07:00, except during the night between Friday and Saturday and the night between Saturday and Sunday (when no night reduction occurs).

### 17.6.3 Editing a schedule

Go down to the first row and press "OK" to enable editing mode.

#### Time

Use the arrow keys to change the time (hours and minutes, respectively).

#### Day by day

Use the arrow keys (up arrow /down arrow) to mark active days in bold.

#### Action Off (On/Off)

This normally indicates whether the row will switch the function "On" or "Off".

However, for the "Night Reduction" and "SmartGrid Schedule" functions, the following applies:

- In the schedule for "Night Reduction", the temperature reduction that will apply during the period is specified in °C here instead. When a temperature is specified (setting range -1 to -30 °C), the status of the row automatically switches to "On".
- When setting a "SmartGrid schedule", the SmartGrid function (SG Block., SG Low price and SG Overcapacity) is specified in the "Action" row. The status of the row automatically switches to "On".

#### Active Yes (Yes/No)

"Yes" means that the row is activated.

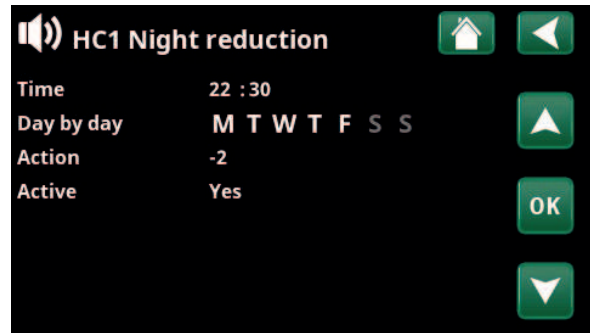

Setting the Night Reduction (-2 °C), weekday nights.



The SmartGrid function "SG Low Price" is scheduled for weekdays 22:30-06:00. Go to the menu by selecting "SmartGrid schedule" in the "Installer/Settings" menu.





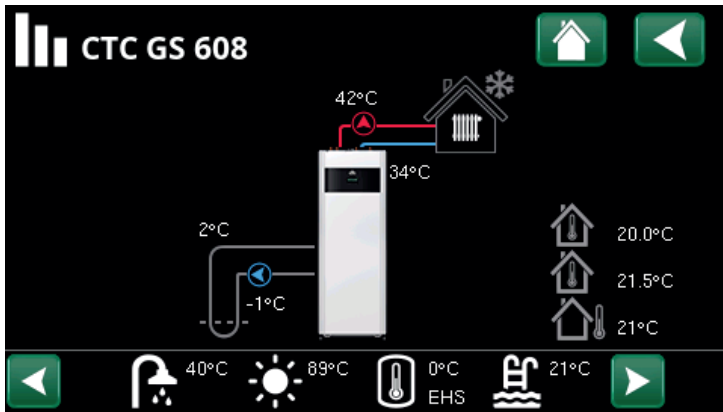

## 17.7 Operation data



**i** NB: The operation values shown in the menu screenshots are only examples.







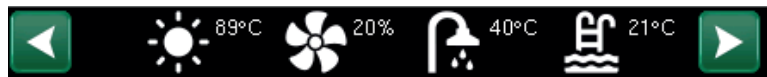

Main menu page for "Operation Data".  
When the pumps are in operation, the pump icons also rotate on screen.

-  **Outside Temperature** Measured temperature, outdoor sensor.
-  **Indoor temperature.** Shows the room temperature for defined heating circuits (room sensors 1 and 2).
-  **Brine temperature** Current temperature (2 °C) of the brine from the collector in the heat pump and return temperature (-1 °C) of the brine back into the collector hose.
-  **Heating circuit** Current primary flow temperature (42 °C) to the house is shown to the left in the menu. Current return temperature (34 °C) is shown below.

The icon bar at the bottom of the menu page displays icons for additional functions or subsystems that have been defined.

Scroll using the arrows or swipe in the list if not all the functions fit on the page.



-  Ventilation
-  Pool
-  Solar Panel
-  Diff thermostat
-  DHW
-  History
-  External DHW tank (EHS)
-  El.prices

The gear icon is a shortcut to "Settings" for the respective part.





### 17.7.1 Operation data, Control unit

Click "Operation Data" in the start menu and then on the top part of the heat pump symbol to display the "Control Unit" menu.

**Status** HC

Current charging mode, see table below.

**DHW tank °C** 49, 45 (55)

Displays the hot water temperatures in the upper and lower parts of the tank. The value in brackets is the setpoint (stop temp). The setpoint is measured in the upper part of the tank.

**Capacity** 75%

Displays the estimated amount of energy remaining for DHW.

**Degree minute** -1000

Shows current heat loss in degree minutes.

**Electric power kW** 0.0

Shows instantaneous power from the immersion heater.

**Current L1/L2/L3 A** 0.0 0.0 0.0

Displays current in phases L1-L3 if current sensor installed. If not configured, only the highest value phase is displayed.

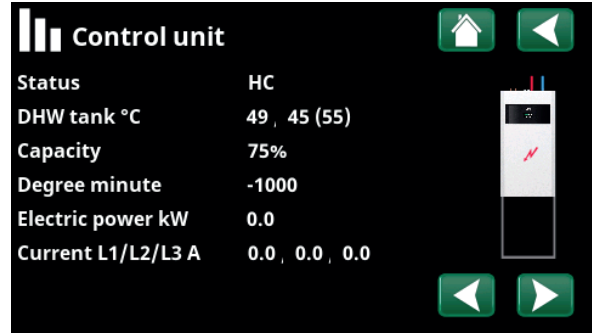

Menu Operation Data/Control Unit. Click the arrows or swipe sideways to switch to the "Operation Data/Heat Pump" menu.

The first figure indicates the current operational value, and the value in brackets indicates the setpoint which the heat pump is trying to achieve.

"Degree minutes" refers to the product of the cumulative heat loss in degrees (°C) and the time measured for this in minutes.

Control unit status	
HC	The heat pump charges the heating circuit.
DHW	The heat pump charges the DHW system.
Pool	The heat pump charges the pool.





## 17.7.2 Operation data, Heating circuit\*

Click on a heating circuit to see more detailed operation data in a new menu window.

**Mode** **Custom**

Shows the active DHW program.

**Status** **Heating**

Shows the operational status of the heating circuit. See the table below.

**Primary flow °C** **42 (48)**

Shows the temperature supplied to the current heating circuit and the setpoint in brackets.

**Return flow °C** **34**

Shows the temperature of the water returning from the heating circuit to the heat pump.

**Room temp. °C** **21 (22) (25)**

Shows the room temperature for the heating circuit if room sensor installed. In brackets, the setpoint is shown for the "Heating" and "Cooling" status.

**Radiator pump** **Off**

Shows the operational status of the radiator pump ("On" or "Off").

**Mixing valve** **Open <50%**

Only displayed for Heating circuit 2.

Shows whether the mixing valve increases (opens) or decreases (closes) the heating flow to heating system 2 and when the mixing valve is in the "<50%" or ">=50%" position.

**SmartGrid** **Off**

Shows the status of the SmartGrid functions for the selected heating circuit.

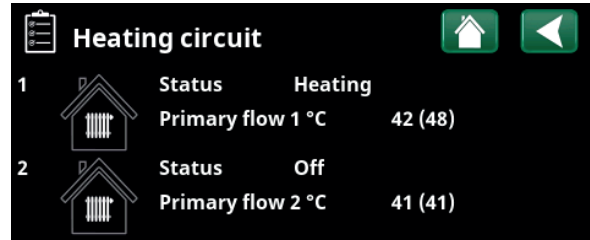

Menu: "Operation data, heating circuit". The menu shows the current temperatures and status of defined heating circuits.

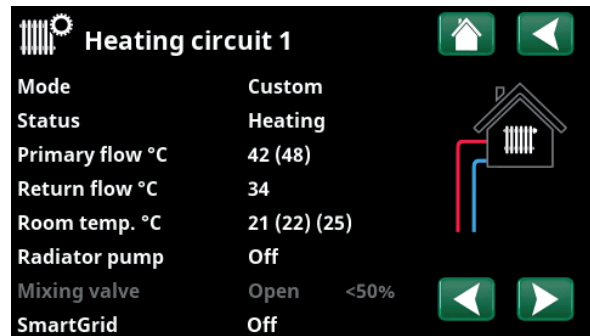

The menu shows detailed operation data of the selected heating circuit. Click the arrows or swipe sideways to view defined heating circuits.

\*The heat pump can control up to 2 heating circuits.

Heating circuit status	
Heating	Heat is produced for the heating circuit.
Cooling	The system produces passive cooling.
Holiday	"Holiday reduction" of room temperature is active. For more information, refer to the "Heating/Cooling" chapter.
Night reduction	"Night reduction" of room temperature is active. For more information, refer to the "Heating/Cooling" chapter.
Off	No heating/cooling produced.



### 17.7.3 Operation data, Heat pump

**Status** **On, heating**

Shows the status of the heat pump. See the table below.

**Compressor** **65rps R**

Displays the compressor speed. Applies only to modulating heat pump CTC GSi 600.

**Charge pump** **On 50%**

Shows operating status of the charge pump ("On" or "Off") and the flow in percent.

**Brine pump** **Off 0%**

Shows operating status of the brine pump ("On" or "Off") and the flow in percent.

**HP in/out °C** **48.0 / 53.0**

Shows the heat pump's return and primary flow temperatures.

**Brine in/out °C** **-2.0 / 1.0**

Shows the heat pump's return and primary flow brine temperatures.

**AC Choke °C** **0.0**

Shows the temperature of the heat pump AC choke. Applies only to modulating heat pump CTC GSi 600.

**Inverter °C** **0.0**

Shows the inverter temperature. Applies only to modulating heat pump CTC GSi 600.

**Software HP PCB** **20210909**

Shows the heat pump software version.

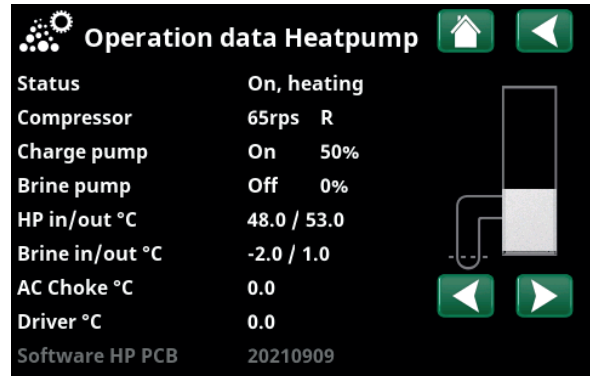

The menu shows the status and operating temperatures of defined heat pumps.

Status heat pump	
Off	Heat pump not charging - no need.
Off, start ready	The heat pump's compressor is off but ready to start.
Blocked in menu	The heat pump's compressor is "Blocked" in the "Installer/Settings/Heat Pump" menu.
Start delay	The heat pump's compressor is off and is prevented from starting due to the start delay.
Communication error HP	The control unit cannot communicate with the heat pump.
On	The heat pump is in the "On" position.
On, DHW	The heat pump heats the DHW tank.
On, cooling	The heat pump is producing cooling for the heating circuit
On, heating	The heat pump is producing heat for the heating circuit.
Driver block under voltage	Driver blocked due to too low operating voltage to the driver.
Driver block alarm	Driver blocked due to a driver alarm.
Stop, tariff	Compressor blocked due to the Tariff remote control function being active.
Alarm	Compressor off due to an alarm.
Blocked, low brine in	Compressor blocked due to too low brine temperature.



## 17.7.4 Stored Operation data

This menu shows cumulative operation values.

The operation values shown in the menu screenshots are only examples. The historical operational info presented varies depending on the language choice.

**Total operation time h** **3500**

Shows the total time the product has been powered.

**Max primary flow °C** **51**

Shows the highest temperature that has been supplied to the heating circuit.

**Energy el. total (kWh)** **250**

Shows how much additional heat has been used.

### Compressor

**Operation time /24 h:m** **07:26**

Shows total operating time during the last 24 hours.

**Total operation time** **1500**

Displays total compressor operating time in hours.

Stored oper. data	
Total operation time h	3500
Max primary flow °C	51
Energy el. total (kWh)	250
Compressor	
Operation time /24 h:m	07:26
Total operation time	1500

Menu: "Operation data/Stored operation data".



## 17.7.5 Operation data, DHW

<b>Mode</b>	<b>Comfort</b>
Shows the active DHW program.	
<b>DHW tank °C</b>	<b>45, 55 (55)</b>
Shows the current temperature in the DHW tank and the setpoint (in brackets) for heat pump operation and during additional heat.	
<b>DHW °C</b>	<b>45 (50)</b>
Displays the DHW temperature and setpoint (in brackets).	
<b>Capacity</b>	<b>50%</b>
Displays the estimated amount of energy remaining for DHW.	
<b>Extra DHW</b>	<b>On</b>
"On" means the "Extra DHW" function is active.	
<b>DHW circulation</b>	<b>Off</b>
"On" means the "DHW circulation" function is active.	
<b>SmartGrid</b>	<b>Off</b>
The status of the SmartGrid functions for DHW is shown here.	

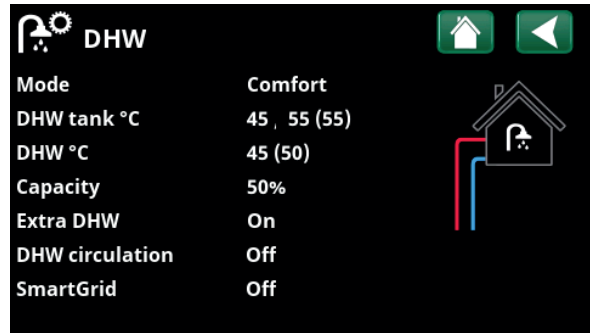

"Operation Data/DHW" menu.



## 17.7.6 Operation data, Diff thermostat function

This menu is displayed if a wood boiler has been defined in the "Installer/Define/Diff Thermostat Function" menu.

<b>Status</b>	<b>On</b>
Shows whether the charge pump is turned on ("On"/"Off").	
<b>Temperature °C</b>	<b>51</b>
Temperature in tank <b>from</b> which it is charged.	
<b>Target temp. °C</b>	<b>43</b>
Temperature in tank that it is charged <b>to</b> .	

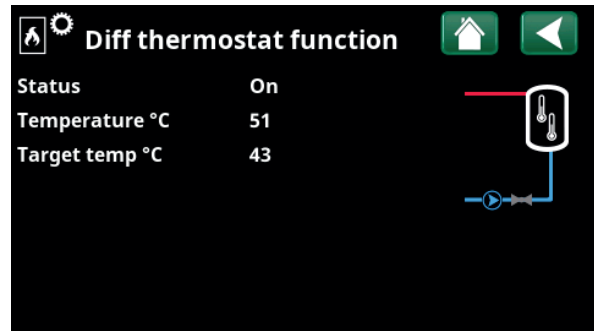

Menu: "Operation Data/Diff. thermostat function".



### 17.7.7 Operation Data, External heat source (EHS)

This menu is displayed if an External Heat Source has been defined in the "Installer/Define/External Heat Source (EHS)" menu.

#### System status DHW

Shows the various operational statuses of the system. Refer to the "Operation info/Control Unit" section.

#### Status On

The status of the external heat source can be "Off" or "On".

#### Temperature °C 47

Shows the current temperature in the EHS tank.

#### Charge start degrees 50

This is the minimum temperature required in the external heat source tank for the mixing valve to open and provide heat to the system.

#### SmartGrid Block. cap. Off

External heat source is blocked by SmartGrid due to "Overcapacity".

#### Mixing valve Closes

Indicates whether the EHS tank mixing valve increases (opens) or reduces (closes).

#### Demand DHW Yes (55)

"Yes" means that there is a need for hot water and that hot water is taken from the EHS tank. The DHW setpoint is shown in brackets.

#### Demand HC No (0)

"Yes" means that there is a need for heat in the heating circuit and that heat is taken from the EHS tank. The heating circuit setpoint is shown in brackets.

#### Demand pool No (0)

"Yes" means that there is a need for heat in the pool and that heat is taken from the EHS tank. The pool setpoint is shown in brackets.

The screenshot shows a dark-themed menu titled "External heat source" with a home icon and a back arrow icon in the top right. The menu items are as follows:

- System status: DHW
- Status: On
- Temperature °C: 47
- Charge start degrees: 50
- SmartGrid Blocking cap: Off
- Mixing valve: Close
- Demand DHW: Yes (55)
- Demand HC: No (0)
- Demand pool: No (0)

On the right side of the menu, there is a schematic diagram of a mixing valve with a thermometer icon overlaid on it.

Menu: "Operation Data/External Heat Source".



### 17.7.8 Operation data, El.prices

This menu is displayed if "El.prices" has been defined in the "Installer/Define/Communication" menu.

**El.price mode** **High**

Indicates the current price category ("High", "Medium" or "Low").

**El.price/kWh** **SEK 7.5**

Indicates the current electricity price in local currency.

Display the "Preview data" graph by clicking the "Graph icon" at the bottom-left of the menu screen.

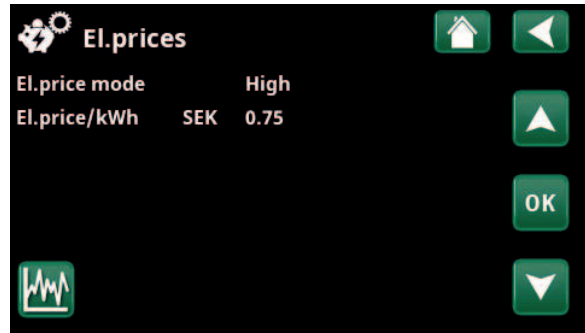

Menu: "Operation/El.prices".

For more information and examples of Smart Electricity Price Control/SmartGrid, see the website [www.ctc-heating.com/Products/Download](http://www.ctc-heating.com/Products/Download).



### 17.7.9 External signal

The menu shows the functions that are active via external control. The functions can be activated with:

- myUplink
- Virtuell digital in
- Modbus
- Relay
- SmartControl sensors

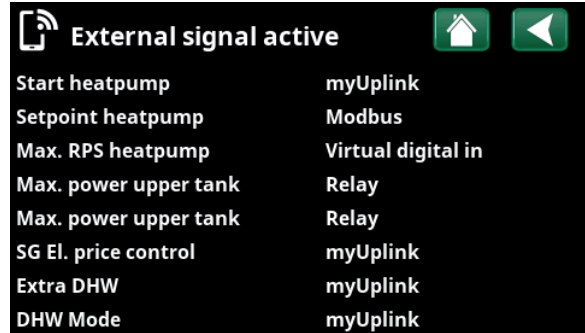

Menu: "Operation/External signal active".



## Installer

This menu contains four sub-menus:

- Display
- Settings
- Define
- Service



For "System Information", click the "i" button in the lower right corner of the screen in the "Installer" menu. This displays the product serial number, MAC address, and application and bootloader versions. Click "Legal Information" to view information regarding third-party licences.

Scan the QR code with a tablet or smartphone. When your phone/tablet is connected to your local network, the product can be used with your device's touchscreen in the same way as the product's screen.

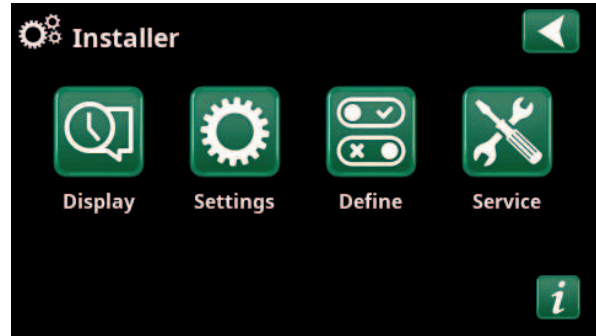

Menu: "Installer".

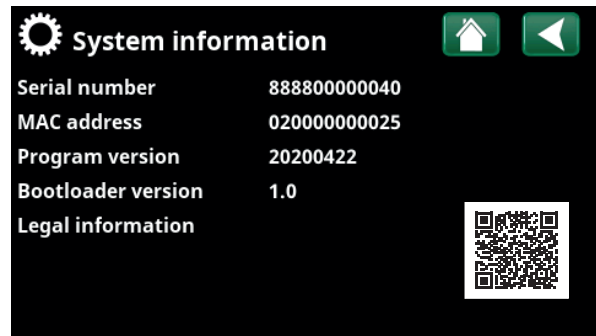

Menu: "Installer/System information". To access this menu, click the "i" button in the lower right corner of the "Installer" menu.



## 17.8 Display

Time, language and other screen settings can be carried out from this menu.



### 17.8.1 Setting the time

#### Time and Date

Click on the time symbol. The menu can also be accessed by clicking the date or time in the upper right corner of the start screen.

Press "OK" to highlight the first value and use the arrows to set the time and date.

#### DST (On, Active)

The left value can be set. "On" means the time is adjusted according to Summer Time.

The right value is fixed and shows the current status (for example, "Off" during the winter period). The display does not need to be connected to power for the values to be adjusted, since this occurs at the next start-up.

#### SNTP

Menu option "On" retrieves the current time from the internet (if online). More settings options can be found in the "Installer/Settings/Communication/Internet" menu.



Menu: "Installer/Display".



Menu: "Installer/Display/Time".



## 17.8.2 Language

Click a flag to select the language. The language selected is highlighted with a green square. To view more language options than those shown in the menu, scroll down the page, or press the down arrow key.



## 17.8.3 Country

Click on the "Country" symbol in the "Installer/Display" menu to display selectable countries and regions. The country that is displayed (highlighted in green) depends on which language has been selected.

"English" is the default language setting, which means that "GB United Kingdom of Great Britain and Northern Ireland" is the default country setting.

Select the country where the plant is installed to get correct spot prices. Depending on which country is selected, product-specific factory settings may vary.

"Country" must also be selected to receive correct electricity prices when controlling electricity prices via the myUplink mobile app.



## 17.8.4 Display setup

**Sleep delay** 120 (Off, 1...360)

Enter the time in minutes before the display enters sleep mode if not touched. Settings can be applied in 10 min. intervals.

**Backlight** 80% (10...90)

Set the brightness of the backlit display.

**Click sound** Yes (Yes/No)

Enable or disable button sounds.

**Alarm sound** Yes (Yes/No)

Enable or disable alarm sounds.

**Time zone, GMT +/-** +1 (-12...14)

Set your time zone (relative to GMT).

**Lock code** 0000

Press "OK" and use the arrows to set a 4-digit lock code. If a lock code is set, it is shown as four stars. You will be prompted to enter the code when the screen is restarted.

NB: Make a note of the lock code for your own reference when you enter it in the menu for the first time.

The serial number of the display (12 digits) can also be entered to unlock the display (enter '0000' + serial number); see chapter "Installer/System Information".

The display can be locked by clicking the product name in the upper left of the start menu, whereupon you will be prompted to enter the lock code.

A lock code can be deleted by entering "0000" in this menu instead of the previously specified lock code.

**Font size** Standard (Small/Standard/Large)

The display's font size can be changed here.

**Selection colour** 0 (0/1/2)

Option to change the cursor background colour for clearer selection according to the light conditions.

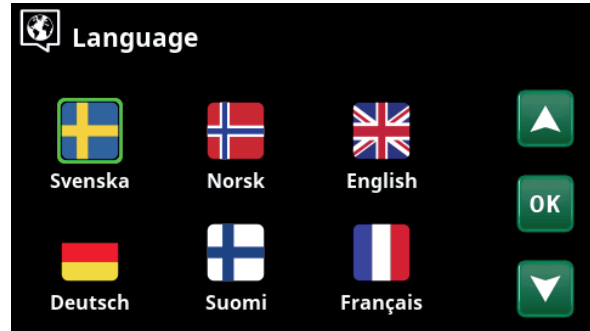

Menu: "Installer/Display/Language".



Menu: "Installer/Display/Country".

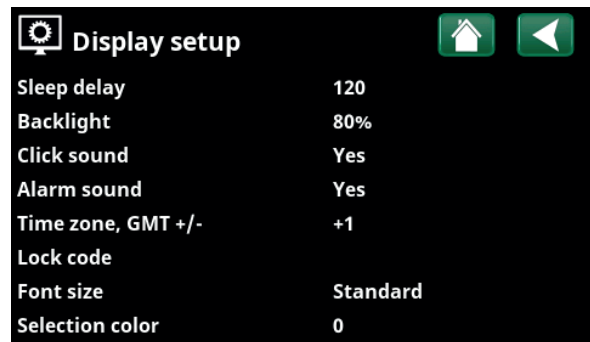

Menu: "Installer/Display/Display Setup".





## 17.9 Settings

This is used to set the parameters for your home's heating requirements. It is important that this basic setting is right for your home. Values which are set incorrectly may mean that your property is not warm enough or that an unnecessarily large amount of energy is being used to heat your property.

**i** First define the desired functions, see "Installer/Define". Settings are only displayed for enabled functions.

### 17.9.1 Settings Heating circuit\*

In the "Settings" menu, select "Heating circuit" and then the heating circuit to be set.

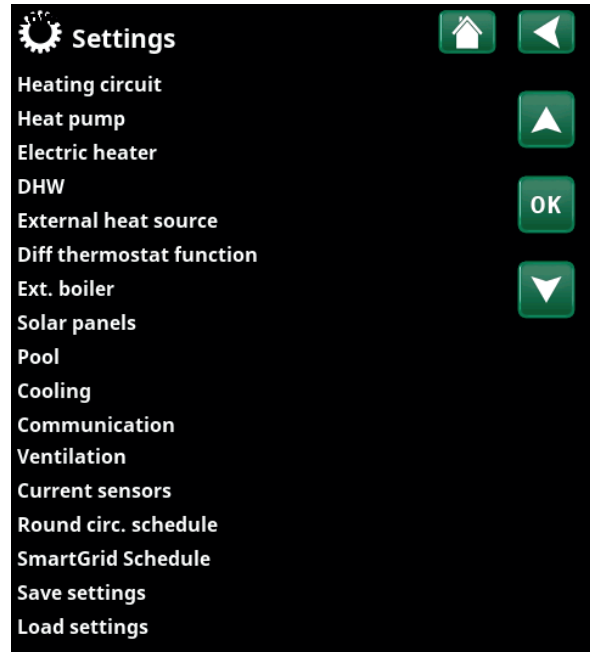

Menu: "Installer/Settings".

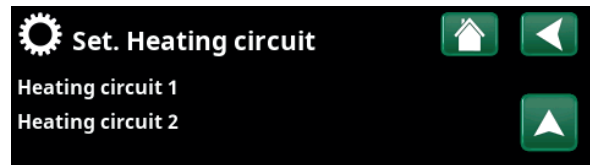

Part of the "Installer/Settings/Heating Circuit" menu.

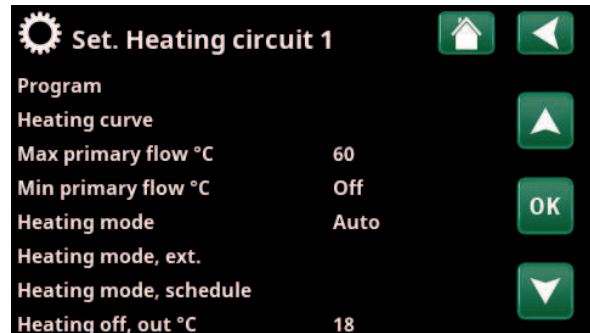

Part of the "Installer/Settings/Heating Circuit/Heating Circuit 1" menu.

\*The heat pump can control up to two heating circuits.

## Program

Press "OK" on the "Program" menu bar to make settings for the "Economy", "Comfort" and "Custom" heating programs. Selected programme is marked with an "X".

To activate a heating program or set a schedule, press the "Program" button from the "Heating/Cooling" menu. See chapter "Control system / heating/cooling".

### • Primary flow change °C **-5 (-20...-1)**

The menu bar is displayed if the room sensor is not defined for the heating circuit. Setting "-5" (factory value program "Economy") means that the setpoint of the primary flow is lowered by 5 °C when the program is active.

### • Room temp change °C **-2.0 (-5.0...-0.1)**

The menu bar is displayed if the room sensor is defined for the heating circuit. Setting "-2" (factory value program "Economy") means that the set setpoint for room temperature is lowered by 2 °C when the program is active.

### • Off delay, min **No (No/10...600)**

Off delay means the time in minutes after the heating program "Economy", "Comfort" or "Custom" has been activated as the heating mode returns to the program "Normal". However, if the "Custom" program is selected later than the "Normal" program, the "Custom" program will apply after the Off delay. The Off delay is adjusted in steps of 10 minutes for each key press (up or down arrow).

"No" means that the selected program will be activated until another heating program is activated.

### • SmartGrid Blocking\* **Off (Off/On)**

The menu bar is displayed when setting the heating programme "Economy" or "Custom".

"On" means that the heating program is activated when "SmartGrid Blocking" is active.

### SmartGrid Low price\* **Off (Off/On)**

The menu bar is displayed when setting the heating programme "Comfort" or "Custom".

"On" means that the room temperature is increased according to the setting for "SmartGrid Low price °C" when "SmartGrid Low price" is active.

### SmartGrid Overcapacity\* **Off (Off/On)**

The menu bar is displayed when setting the heating programme "Comfort" or "Custom".

"On" means that the room temperature is increased according to the setting for "SmartGrid Overcapacity °C" when "SmartGrid Overcapacity" is active.

### • Reset program

Current program is reset with factory values.

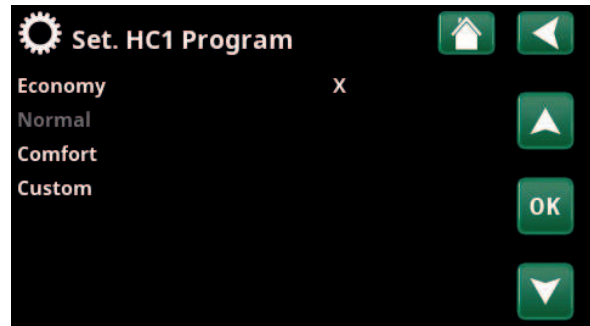

Menu "Installer/Settings/Heating Circuit/Heating Circuit 1/Program".

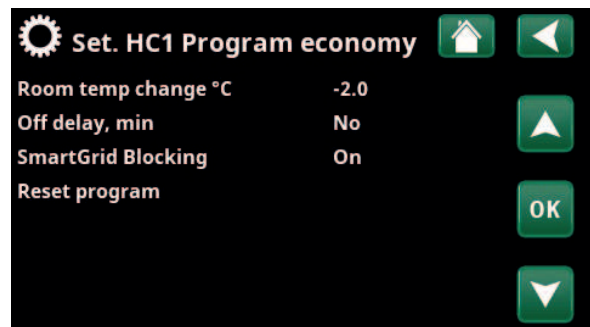

Menu "Installer/Settings/Heating Circuit/Heating Circuit 1/Program/Economy".

\*SmartGrid functions are set in the menu "Installer/Settings/Heating circuit".

## Heating curve

The heating curve determines the primary flow temperature (and thus the indoor temperature) to the heating circuit at different outdoor temperatures.

See chapter "Your home's heating installation" for more information on adjusting the heating curve.

Possible choices are "Set. heating curve", "Fine adjustment", "Active curve", "Copy from ..." and "Reset curve".

### • Set. heating curve

The thicker line shows the factory-set curve while the thinner line shows the active heating curve to be reset. Here it is possible to adjust the appearance of the graph by adjusting the curve inclination and curve adjustment with the buttons below the graph. The adjustments you make here affect the entire appearance of the graph, while the changes made under "Fine adjustment" are made one point at a time. Curve inclination is adjusted with the left and right arrows while curve adjustment is adjusted with the up and down arrows. Confirm with "OK".

### • Fine adjustment

The graph of the active heating curve for the heating circuit is displayed. The heating curve can be adjusted in 5 points on the graph. Touch a point (becomes green) to change its position in the x-axis (outdoor temperature) and y-axis (primary flow temperature). Use the up/down/left/right buttons below the graph or press and drag the point.

Below the graph, the outdoor and primary flow temperatures for the selected point are shown. The heating curve can also be adjusted from the "Heating/Cooling" menu. See chapter "Control system / heating/cooling".

### • Active curve 1 (1/2)

This menu bar shows the selected heating curve, it is possible to choose between two different heating curves per heating circuit.

### • Copy from 1 (2)

The function "Copy from ..." is useful if you have created two different heating curve graphs but want to restore one graph to the same appearance as the other and then make changes.

Example: If heating curve 1 is selected as "Active curve", heating curve 1 will have the same appearance as heating curve 2 by selecting the line "Copy from 2" and pressing "OK". The menu bar cannot be selected (marked with gray) when heating curves 1 and 2 have the same values (the graphs look the same).

### • Reset curve

Resets the active heating curve to the factory-set curve.

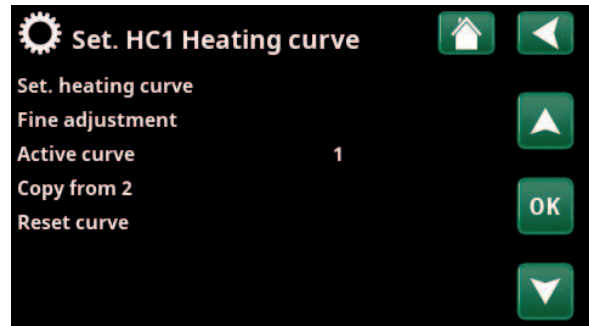

Menu "Installer/Settings/Heating Circuit/Heating Circuit 1/Heating curve".

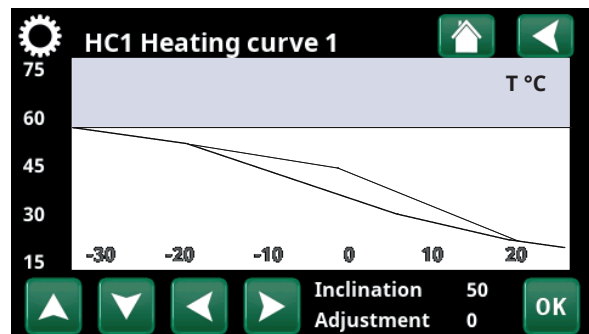

Menu "Installer/Settings/Heating Circuit/Heating Circuit 1/Heating curve".

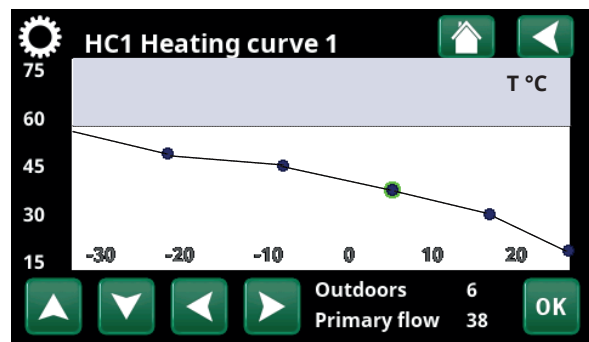

Menu "Installer/Settings/Heating Circuit/Heating Circuit 1/Heating curve/Fine adjustment".

**Max primary flow °C** 60 (30...70)

Maximum permitted temperature supplied to the respective heating circuit.

**Min primary flow °C** Off (Off/15...65)

Minimum permitted temperature supplied to the respective heating circuit.

**Heating mode** Auto (Auto/On/Off)

Switching between heating season and summer mode can take place automatically (Auto) or a selection can be made here to set the heating to "On" or "Off".

Heating mode can also be selected from the start page by pressing the "Mode" button in the Heating/Cooling menu.

- **Auto** = switching the heating season On and Off carried out automatically.
- **On** = Continuous heating season, the radiator pump circulates constantly.
- **Off** = there is no heating, the radiator pump does not run (is turned over).

**Heating mode, ext.** - (Auto/On/Off)

The heating mode selected in this menu can be enabled/disabled externally.

This menu bar is displayed for the current heating circuit if a remote control input or a schedule has been defined for the function.

Read more in the "Def. Remote Control" section of the "Installer/Define" chapter.

#### Heating mode, schedule

This menu bar is displayed if a schedule has been defined for the "HC Heating mode, ext." function in the remote control menu.

For more information, refer to:

- chapter "Schedule".
- section "Def. Remote Control" of the "Installer/Define" chapter for defining the remote control function.

**Heating off, out °C** 18 (2...30)

**Heating off, time (min)** 120 (30...1440)

**Heating on, time (min)** 120 (30...1440)

The menu bars can only be set if the "Auto" mode is selected in the "Heating mode" menu above. Otherwise, the menu bars are locked (greyed out).

When the outdoor temperature exceeds (or equals) the set value in the "Heating off, out °C" menu during the time (in minutes) set in the "Heating off, time (min)" menu, the production of heat for the house is stopped.

This means the radiator pump stops, and the mixing valve remains closed. The radiator pump is activated daily for a short period to prevent it from jamming. The system restarts automatically when heating is needed.

When the outdoor temperature drops to the limit where heating is needed again, heat to the house is permitted when the temperature falls below (or equals) the set value in the "Heating off, out °C" menu for the number of minutes set in the "Heating on, time (min)" menu.

Menu "Installer/Settings/Heating Circuit/Heating Circuit 1".

**Night reduction down to °C** **5 (-40...40)**

When the outdoor temperature is lower than this, the "Night Reduction" function stops since too much energy is consumed and it takes too long to increase the temperature again.

This menu overrides remote control of "Night Reduction".

**Room temp. reduced, Night red °C** **-2 (0...-30)****Room temp. reduced, Holiday °C** **-2 (0...-30)**

The menus are displayed if room sensors are installed for the heating circuit. The number of degrees by which the room temperature should be lowered during remote-controlled night reduction and during holidays can be set here. Night reduction can also be set periodically; the temperature decrease is then entered in the schedule.

**Prim. flow reduced, Night red °C** **-3 (0...-30)****Prim. flow reduced, Holiday °C** **-3 (0...-30)**

The menus are displayed if room sensors are not installed for the heating circuit. The number of degrees by which the primary flow temperature for the heating circuit should be lowered during remote-controlled night reduction and during holidays can be set here. Night reduction can also be set periodically; the temperature decrease is then entered in the schedule.

**Alarm room temp °C** **5 (-40...40)**

If the room temperature is too low (according to the set value), the message "Alarm, low room temp." will be displayed.

This menu bar is displayed if the room sensor is connected and defined.

**SmartGrid Low Price °C** **1 (Off/1...5 )**

Setting to increase the room temperature at "Low price" energy price, via SmartGrid.

Both SmartGrid A and SmartGrid B must be defined in the remote control menu for this menu to be displayed.

Read more in the "Remote Control/SmartGrid A/B" section of the "Installer/Define" chapter.

**SmartGrid Overcapacity °C** **2 (Off/1...5)**

Setting to increase the room temperature at "Overcapacity" energy price, via SmartGrid. This function is not used for electricity price control.

Both SmartGrid A and SmartGrid B must be defined with a remote control input for this menu to be displayed.

Read more in the "Remote Control/SmartGrid A/B" section of the "Installer /Define" chapter.

**SmartGrid Blocking** **Off (Off/On)**

"On" means the heating circuit is blocked at "High" energy price, via SmartGrid. If the outdoor temperature falls below the value set in the "Night reduction down to °C" menu, this function is not activated.

Both SmartGrid A and SmartGrid B must be defined with a remote control input for this menu to be displayed.

Read more in the "Remote Control/SmartGrid A/B" section of the "Installer /Define" chapter.

● If room sensors are installed, the "Room temp reduced..." menu is displayed. If there are no room sensors, the "Primary flow reduced..." menu is displayed.

**Example**

As a rule, a "Primary flow reduced" reduced value of 3 to 4 °C is equivalent to a reduction of approximately 1 °C in room temperature in a normal system.

**Max time heating (min) 20 (10-120)**

This is the maximum time (minutes) during which the heat pump charges the heating circuit if needed in the hot water tank.

**Charge pump % 60\* (20-100)**

Setting for charge pump (G11) speed (percent) when charging the heating circuit.

**Drying period mode Off (Off/1/2/3)**

Applies to Heating circuit 1. Drying period for newly built properties. The function limits the calculation of primary flow temperature (setpoint) for "Your home's heating settings" to the schedule below.

**Mode 1 - Drying period for 8 days**

1. The setpoint of the radiator system is set to 25 °C for 4 days.
  2. On Days 5-8, the set value in "Drying period temperature °C" is used.
- (From Day 9 onwards the value is calculated automatically according to "Your home's heating settings").

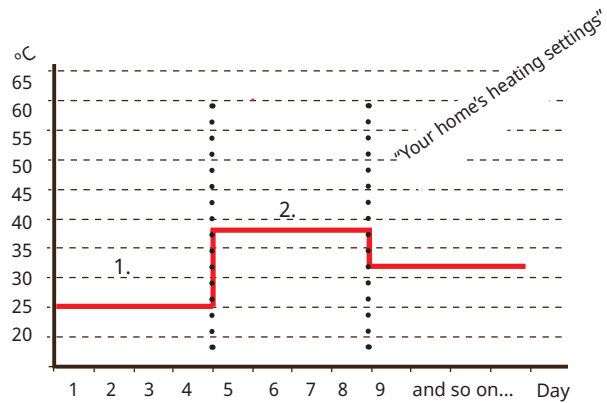

Example: Mode 1 with set value "Drying period temp °C": 38.

**Mode 2 - Drying period for 10 days + stepped increased and decrease**

1. Stepped increase start: The setpoint of the radiator system is set to 25 °C. The setpoint is then raised by 5 °C each day until it is equal to the "Drying period temp °C". The final step may be less than 5 °C.
  2. Drying period for 10 days.
  3. Stepped decrease: After the stepped increase and 10 days at an even temperature, the temperature setpoint is reduced to 25 °C in daily 5 °C stages.
- The final step may be less than 5 °C.

(Following the stepped decrease and 1 day at the setpoint of 25 °C, the value is calculated automatically according to "Your home's heating settings").

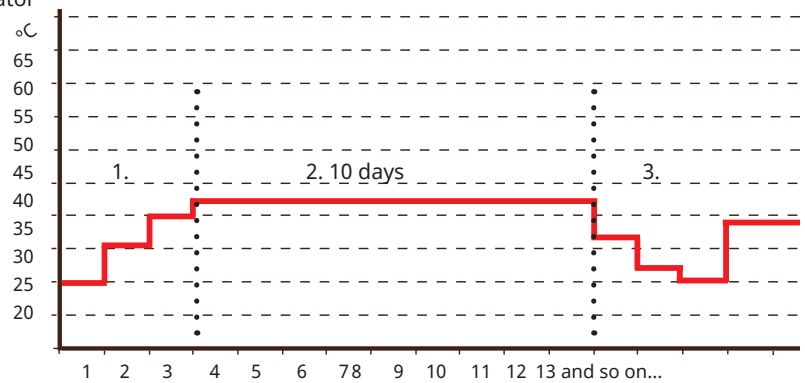

Example: Mode 2 with set value for "Drying period temp °C": 37.

**Mode 3**

In this mode, the function starts in "Mode 1" followed by "Mode 2" and lastly by "Your home's heating settings".

**Drying period temp °C 25 (25...55)**

The temperature for "Mode 1/2/3" as shown above is set here.

**Drying period mode Off (Off/On)**

This menu bar is displayed for Heating Circuit 2 if a heating mode (1-3) is selected in the "Drying period mode" menu above.

The "On" option means that the drying period mode selected for Heating Circuit 1 will also be run for the selected heating circuit.

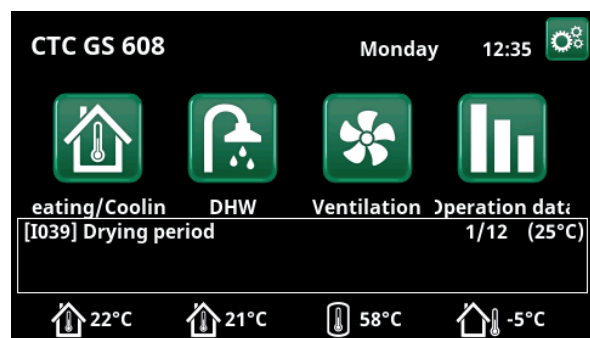

Example: Drying period temperature day 1 of 12 with current set point of 25 °C.

\*The value may vary depending on the heat pump model.

## 17.9.2 Settings Heat pump

### Compressor **Blocked (Permitted/Blocked)**

The heat pump is supplied with a blocked compressor. "Permitted" means that the compressor is allowed to start.

### Brine pump **Auto (Auto/10 days/On)**

After installation is complete, you can choose to run the brine pump constantly for 10 days to remove air from the system. The brine pump then enters "Auto" mode. "On" means the brine pump runs constantly.

### Compressor stop at brine °C **-5 (-15...10)**

Specify the brine temperature at which the compressor should stop.

### Tariff HP **No (No/Yes)**

"Yes" means the function can be activated via remote control.

Read more in the "Def. Remote Control" section of the "Installer/Define" chapter.

### Tariff HP schedule

This menu bar is displayed if a schedule has been defined for the "HP Tariff" function.

For more information, refer to:

- chapter "Schedule".
- section "Def. Remote Control" of the "Installer/Define" chapter for defining the remote control function.

### SmartGrid Block. HP **No (No/Yes)**

"Yes" means that the heat pump is blocked when "SmartGrid Blocking" is active.

Read more in the "Remote Control/SmartGrid" section of the "Installer/Define" chapter.

### Start at degree minute **-60 (-900...-30)**

The degree minute at which Heat Pump 1 (HP1) will start is entered here.

### Max RPS **100 (50...100)**

Maximum permissible speed of the compressor.

The setting range may vary depending on the heat pump model.

### Noise reduction, schedule

Applies only to modulating heat pump CTC GSi 600.

### Ext. silent mode RPS **50 (50...100)**

Applies only to modulating heat pump CTC GSi 600.

### Passive cooling brine pump On **Off (On/Off)**

Enable "Yes" if the brine pump should be used for passive cooling.

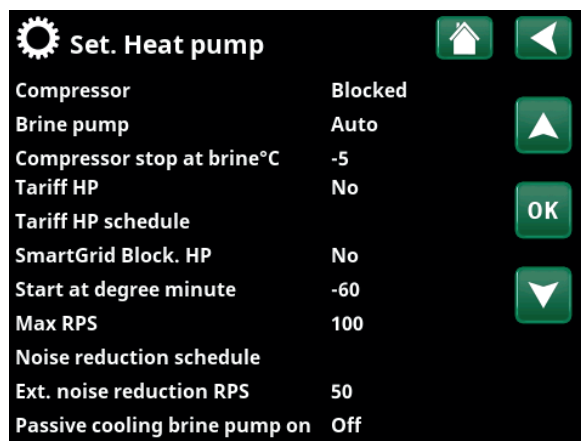

Menu: "Installer/Settings/Heat Pump".

### 17.9.3 Settings Immersion heater

**Max el. heater kW** 9.0 (0.0...9.0)

Here you select the power that the immersion heater is permitted to provide.

The setting range may vary depending on the heat pump model.

The setting range varies, see "Electrical data" in the chapter "Technical data". For language choices "German" and "French" the max electric power is factory set at 0.0 kW.

**Max el. heater DHW kW** 0.0 (0.0...5.8)

Here you select the power that the lower immersion heaters are allowed to emit.

The setting range varies, see "Electrical data" in the chapter "Technical data". For "Country" Germany and France, the max electric power is factory set at 0.0 kW.

**Start at degree minute** -500 (-900...-30)

This menu is used to define at how many degree minutes the immersion heater should start.

**Diff step, degree minute** -50 (-300...-20)

This menu is used to define the difference in degree minutes between the start and stop conditions for the immersion heater. If the immersion heater is started at -500 degree minutes, it will be stopped at -450 degree minutes (for a setting of -50).

**Main fuse A** 20 (10...90)

The property's main fuse size is set here. This setting and the fitted current sensors ensure the fuses are protected when using appliances which generate temporary power peaks, for example, cookers, ovens, engine heaters, etc. The product temporarily reduces power drawn where this type of equipment is being used.

**Conv. factor current sensor** 1 (1...10)

This menu is used to specify the conversion factor the current sensor should use. This setting is only performed if the connection has been installed for a current sensor for higher currents.

Example: User (set) value 2 => 16 A will be 32 A.

**Tariff EL** No (Yes/No)

This menu bar is displayed if an "Input" for remote control is defined for the "Tariff EL" function in the "Installer/Define/Remote Control" menu.

"Yes" means the function can be activated via remote control.

Read more in the "Installer/Define/Remote Control/Tariff EL" chapter.

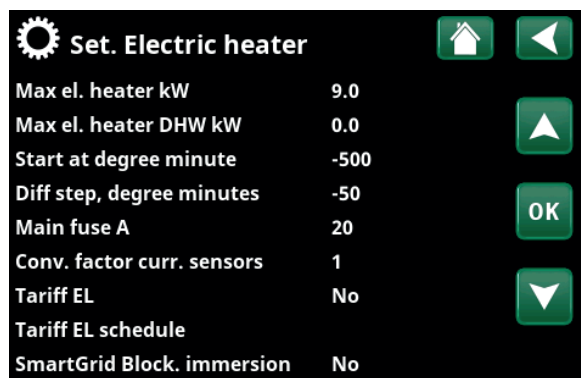

Menu: "Installer/Settings/Immersion heater".

#### Tariff EL schedule

This menu bar is displayed if a "Schedule" is defined for the "Tariff EL" function in the "Installer/Define/Remote Control" menu.

For more information, refer to:

- chapter "Schedule".
- section "Def. Remote Control" of the "Installer/Define" chapter for defining the remote control function.

**SmartGrid Block. immersion** No (Yes/No)

For this menu to be displayed, define a remote control input for both SmartGrid A and SmartGrid B.

"Yes" means that the additional heat is blocked when "SmartGrid Blocking" is active.

Read more in the "Installer/Define/Remote Control" chapter.



## 17.9.4 Settings DHW

The menus below are displayed if "DHW" has been defined in the "Installer/Define /DHW" menu. Sensor B5 measures the temperature in the DHW tank.

### DHW program

Available options are "Economy", "Normal" and "Comfort".

Press "OK" to open the settings for the selected DHW program. The factory settings shown below apply to "Normal" mode. Refer to the "Parameter List" chapter for the "Economy" and "Comfort" modes' factory settings.

#### • Charge start% **No (No/50...90)**

Value Charge start: 60% indicates that the charging of hot water is allowed to start when the amount of hot water is estimated to be "60%" or less. "No" means that the estimated amount of hot water does not affect the start of the hot water charging.

#### • Charging stop upper/lower °C **56\* (20...65)**

Charging of the hot water is complete when both sensors have reached the set value.

\*Gäller CTC GS 608 (CTC GS 606: 55 °C).

#### • Charge start lower °C **40 (15...60)**

Hot water charging starts when the temperature falls below the set temperature.

#### • DHW °C **50 (38...65)**

The DHW out temp.

#### • Restore program

The current DHW program will be restored to factory settings.

#### Start/stop diff. upper °C **5 (3...7)**

This menu is used to set the negative hysteresis before the heat pump starts charging the DHW tank after the setpoint has been reached.

Example: If the stop temperature is 55 °C and hysteresis is set to 5 °C in this menu, it means the heat pump will start DHW charging again when the temperature in the tank has dropped to 50 °C.

#### Max time DHW (min) **30 (10...150)**

This specifies the maximum time for which the heat pump heats the DHW tank.

#### Charge pump % **90 (20...100)**

The charge pump speed is set here.

#### SmartGrid Blocking °C **Off (Off/-1...-50)**

The setpoint for DHW tank heating is decreased by the value set in this menu when "SmartGrid Blocking" is active.

Both SmartGrid A and SmartGrid B must be defined in the remote control menu for this menu to be displayed.

Read more in the "Def. Remote Control /SmartGrid A/B" section of the "Installer/Define" chapter.

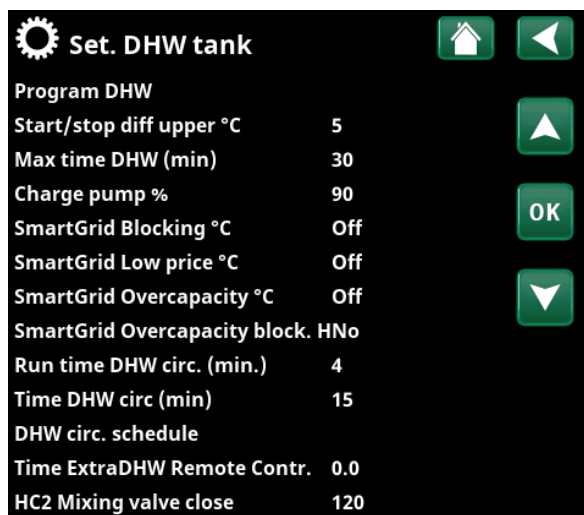

Part of the "Installer/Settings/DHW" menu.

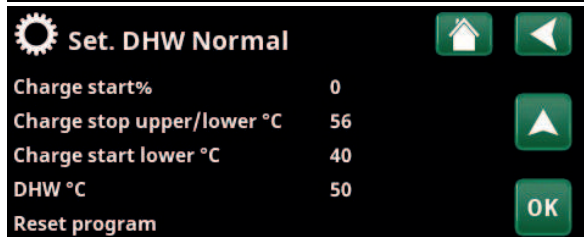
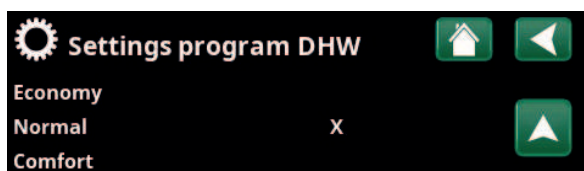

Menu: "Installer/Settings/DHW/DHW Program".

**SmartGrid Low price °C** **Off (Off/1...30)**

The setpoint for DHW tank heating is increased by the value set in this menu when "SmartGrid Low price" is active.

Both SmartGrid A and SmartGrid B must be defined in the remote control menu for this menu to be displayed.

Read more in the "Def. Remote Control /SmartGrid A/B" section of the "Installer/Define" chapter.

**SmartGrid Overcapacity °C** **Off (Off/1...30)**

The setpoint for DHW tank heating is increased by the value set in this menu when "SmartGrid Overcapacity" is active.

Both SmartGrid A and SmartGrid B must be defined with a remote control input for this menu to be displayed.

Read more in the "Def. Remote Control /SmartGrid A/B" section of the "Installer/Define" chapter.

**SmartGrid Overcapacity block HP** **No (No/Yes)**

"Yes" means that DHW tank heating using the heat pump is blocked when "SmartGrid Overcapacity" is active.

**Run time DHW circ. (min)** **4 (1 to 90)**

The length of time that DHW circulation should active during each period. Displayed if "DHW circulation" has been defined in the "Installer/Define/DHW" menu.

**Time DHW circ. (min)** **15 (5...90)**

Time between periods of DHW circulation. Displayed if "DHW circulation" has been defined in the "Installer/Define/DHW" menu.

**DHW circ. schedule**

This menu displays the scheduled weekday periods when the DHW circulation pump is to run. The menu bar is displayed if:

- "DHW circulation" has been defined in the "Installer/Define/DHW" menu.
- a "Weekly Program" is defined for the DHW Circulation" function in the "Installer/Define/Remote Control" menu.

For more information, refer to:

- chapter "Weekly Program" for schedule setting.
- section "Def. Remote Control" of the "Installer/Define" chapter for defining the remote control function.

**Time ExtraDHW Remote Contr.** **0.0 (0.0...10.0)**

The duration of time that extra DHW will be produced for the DHW tank is set here. The "Extra hot water" function is activated via remote control.

The menu bar is displayed if:

- a normal mode for the external control signal (Normally Open (NO)/Normally Closed (NC)) is defined for the function in the "Installer/Define/DHW Tank" menu.
- an "Input" for "Extra DHW" has been defined in the "Installer/Define/DHW tank" menu.

**HC2 Mixing valve close** **120 (Off/1...300)**

The time in seconds to position the mixing valve at 50%. This is done to prevent flow problems when charging DHW.

This menu is displayed if heating circuit 2 is defined.

## 17.9.5 Settings External heat source (EHS)

**Charge start °C** 70

This is the minimum temperature required in the external heat source tank (B47) for the mixing valve to open and emit heat to the system.

**Stop diff °C** 5

Temperature difference before charging stops from the additional heating source.

**SmartGrid Blocking cap.** No (No/Yes)

Electric operation prioritised. The shunt on the EHS tank is closed to accumulate heat energy.

Read more in the "Installer/Define/Remote control/SmartGrid" menu.

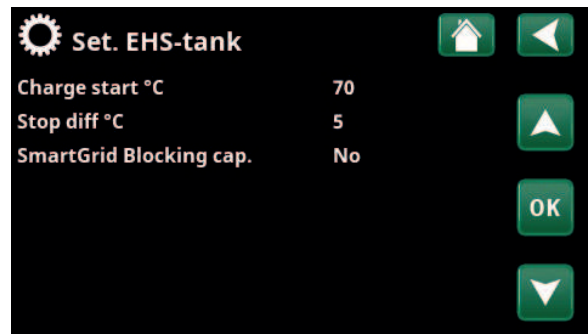

Menu: "Installer/Settings/External Heat Source".

## 17.9.6 Settings Diff thermostat function

The function must be defined before the settings can be entered. Diff thermostat function is used to charge the system tank from a different heat source.

**Charge start diff temp °C** 7 (3...30)

Here you can set the temperature difference determining when charging from the heat source is started. The heat source must be this many degrees warmer than the tank temperature for charging to start.

**Charge stop diff temp °C** 3 (2...20)

The temperature difference which determines when charging from the heat source is stopped is set here. When the temperature difference between the product and the tank falls below this set value, charging stops.

**Charge temperature °C** 60 (10...80)

The maximum permitted temperature in the lower tank is set here. The charging stops if this temperature is exceeded.

**Charge tank** No (No/Yes)

Overcharging from the heat pump's lower tank to the buffer tank starts when:

- Setting menu bar "Charge tank" = "Yes".
- "SmartGrid Low price" or "SmartGrid Overcap." is active and a temperature increase via SmartGrid is set in the lower tank.
- The heat pump charges the buffer tank and the temperature in the lower tank is 5 °C higher than the previous set point\* and the temperature in the buffer tank is 5 °C lower than the previous set point\*.

Overcharging to the buffer tank continues until:

- The heat pump stops charging the lower tank (the need to charge the tank has disappeared).
- The temperature in the lower tank has dropped to the setpoint.
- "SmartGrid Low Price/Overcap." is not active.

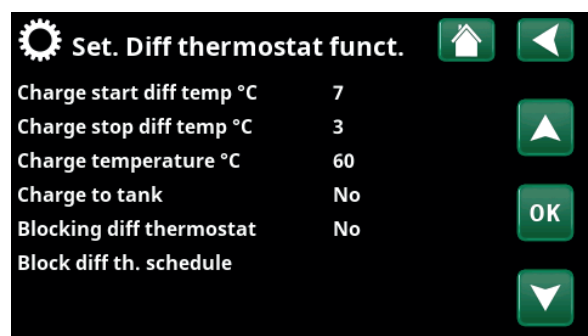

Menu: "Installer/Settings/Diff Thermostat Function".



Ensure a high flow on the pump (G46) so that a low temperature difference of approx. 5-10°C is achieved over the EHS tank during charging.

**Block diff thermostat** No (No/Yes)

"Yes" means the function can be activated via remote control.

**Block diff th. schedule**

Access function scheduling from the "Block diff th. schedule" row.

\*Previous setpoint means the setpoint before "SmartGrid Low Price" or "SmartGrid Overcap." was activated.

## 17.9.7 Settings Cooling

**Room temp. cooling °C** 25.0 (10.0...30.0)

This is used to set the desired room temperature for cooling.

**SmartGrid Low price °C** Off (Off/1...5)

The setpoint for room temperature is decreased by the value set in this menu when "SmartGrid Low price" is active.

The menu bar is displayed if SmartGrid have been defined in the "Installer/Define/Remote Control" menu.

Read more in the "Remote Control/SmartGrid" section of the "Installer/Define" chapter.

**SmartGrid Overcapacity °C** Off (Off/1...5)

The setpoint for room temperature is decreased by the value set in this menu when "SmartGrid Overcapacity" is active.

The menu bar is displayed if SmartGrid have been defined in the "Installer/Define/Remote Control" menu.

Read more in the "Remote Control/SmartGrid" section of the "Installer/Define" chapter.

**Ext. block cooling** No (No/Yes)

Selecting "Yes" enables blocking of cooling. The function can be used to turn off cooling with the help of a humidity sensor when there is a risk of condensation.

### Block cooling schedule

This menu is used to schedule the weekday periods during which cooling should be blocked. This schedule is repeated every week.

This menu bar is displayed if a "Schedule" has been defined for the "Block Cooling" function.

For more information, refer to:

- chapter "Schedule".
- section "Def. Remote Control" of the "Installer/Define" chapter for defining the remote control function.

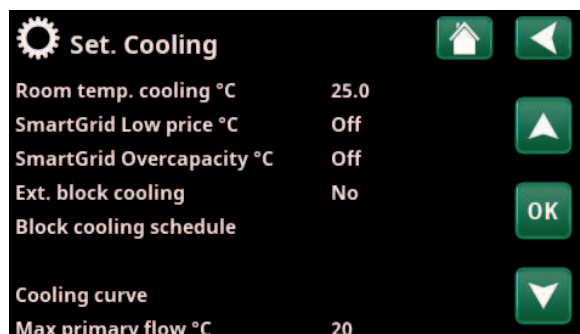

Menu: "Installer/Settings/Cooling".

## 17.9.8 Settings Communication

Settings can be made here to control the product with a control system.

### 17.9.8.1 Settings Ethernet

**DHCP** Yes (Yes/No)

"Yes" enables automatic connection to the network.

If "No", custom router settings (IP address, Netmask and Gateway) as well as DNS setting must be made.

**Auto DNS** Yes (Yes/No)

If "Yes", default DNS server settings are used. If "No", custom DNS settings must be made.

**SNTP Server**

Option for custom SNTP server settings.

**Connection speed** 100mbit

Connection speed is specified here.

The factory-set connection speed is 100 mbit/s.

 For more information about connecting an ethernet cable, refer to the "Installation, Communication" chapter of this manual.

### 17.9.8.2 Settings BMS

**MB address** 1 (1...255)

Adjustable "1-255".

**Baudrate** 9600 (9600/19200)

Possible settings: "9600" or "19200".

**Parity** Even (Even/Odd/None)

Possible settings: "Even", "Odd" or "None".

**Stop bit** 1 (1/2)

Possible settings: 1 or 2.

**Modbus TCP Port** 502 (1...32767)

This menu bar is displayed if "Modbus TCP" is defined in the "Ethernet" row in the "Installer/Define/Remote Control" menu.

### 17.9.8.3 myUplink

The menu is used for pairing with the myUplink app. Request connection string by pressing "Get connection string", confirm with "OK". The menu bar is clickable if the display is connected to the server.

In the app: Scan the QR code or enter values for "Serial number" and "Connection string".

Select the menu items "Remove users" and / or "Remove service partners" to disconnect these accounts from the system. Confirm with "OK".



Menu: "Installer/Settings/Communication".

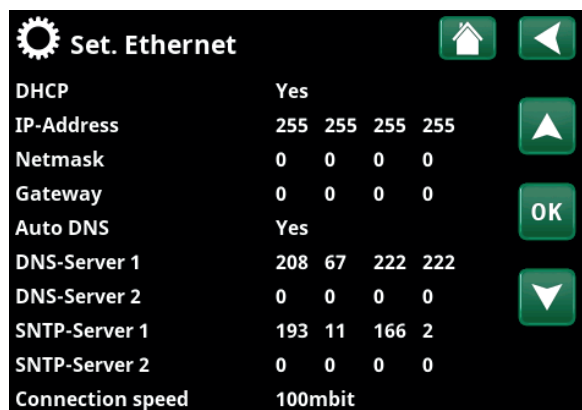

Menu: "Installer/Settings/Communication/Internet".

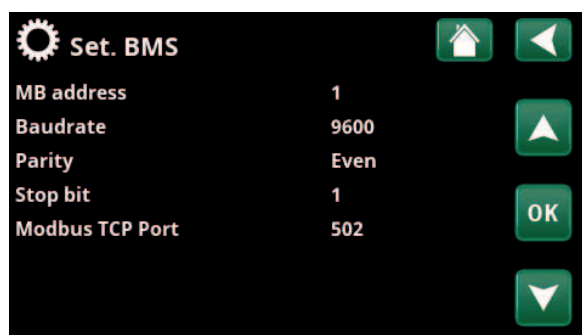

Menu: "Installer/Settings/Communication/BMS".



Menu: "Installer/Settings/Communication/myUplink".

#### 17.9.8.4 Settings El. prices

Ensure that "myUplink" is selected in the "Def. Communication" menu.

Select "El.prices" in the "Installer/Settings/Communication" menu to access the "Set. El.prices" menu.

##### Price control On/Off

Select "On" to show the other menu lines of the "Set. El.prices" display menu.

##### Regions SE01/SE02/SE03/SE04

Click "OK" on the "Regions" line. If "Regions" are defined for the selected country (see "Installer/Display/Country" menu), price regions for the country are shown here. Otherwise, the text "No regions available" is displayed. In this example, Swedish price regions are displayed.

##### Dynamic Yes/No

"Yes" means that the electricity prices are calculated according to price algorithms that define the price categories ("High", "Medium" and "Low").

Click "OK" on the "Preview data" line to display a graph of electricity prices calculated over the selected time interval ("Days in calculation").

The graph can also be displayed by clicking the "El.prices" icon in the "Operation" main menu (see "Operation" section).

##### Limit value high

Set the limit value above which the electricity price is defined as "High" (in the example, the limit value is SEK 3.50). This can be used together with the dynamic price calculation feature to define a different "High" price range than that determined by the dynamic price calculation feature.

Prices defined as "High" activate the "SmartGrid Blocking" function.

##### Limit value low

Set the limit value below which the electricity price is defined as "Low" (in the example, the limit value is SEK 1.50). This can be used together with the dynamic price calculation feature to define a different "Low" price range than that determined by the dynamic price calculation feature.

Prices defined as "Low" activate the "SmartGrid Low price" function.

##### Default High/Medium/Low

Select the price category that should apply if prices cannot be retrieved.

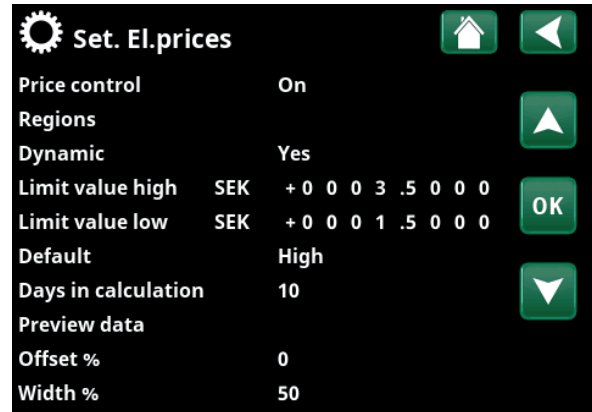

Menu: "Installer/Settings/Communication/El.prices" where "Installer/Define/Communication/myUplink:Yes" is selected.

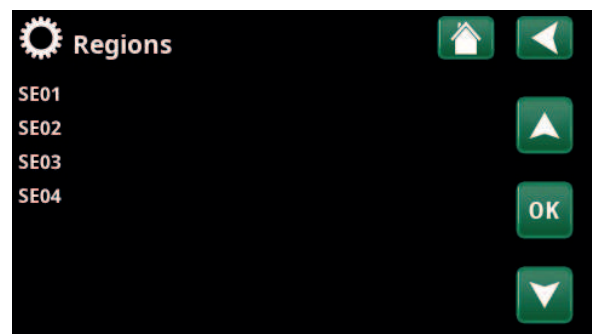

Menu: "Installer/Settings/Communication/El.prices/Regions" where "Installer/Define/Communication/myUplink:Yes" is selected

For more information and examples of Smart Electricity Price Control/SmartGrid, see the website [www.ctc-heating.com/Products/Download](http://www.ctc-heating.com/Products/Download).

**Days in calculation****1...10**

Select the number of days on which the dynamic calculation of the electricity price will be based. Since the dynamic calculation is based on the average price per day, more days in calculation result in a more stable and reliable value.

See also the "Example: Electricity price settings" section.

**Preview data**

Click "Preview data" to show electricity prices during the selected period in graph form.

**Offset %****0 (0...100)**

Enter code "4003" in the "Installer/Service/Coded settings/Code" menu to display the "Offset %" menu line.

"Offset" is the boundary between where "High" price and "Medium" price electricity is determined and is based on the average price for the number of days used in the calculation.

See also the "Example: Electricity price settings" section.

**Width %****50 (0...200)**

Enter code "4003" in the "Installer/Service/Coded settings/Code" menu to display the "Width %" menu line.

"Width" is the vertical price range where the electricity price is considered "Medium".

See also the "Example: Electricity price settings" section.

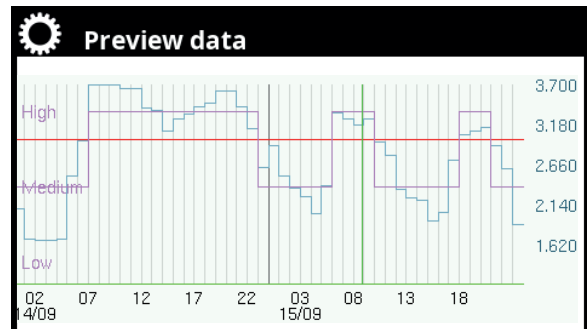

Menu: "Installer/Settings/Communication/El.prices/Preview data".

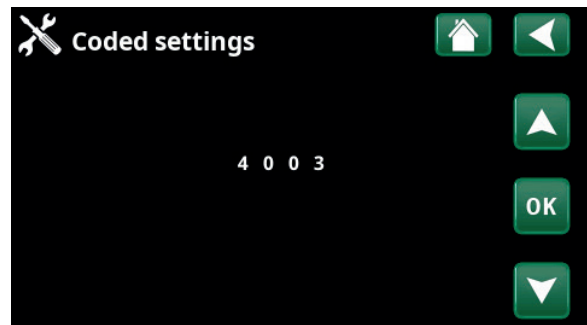

Menu: "Installer/Service/Coded settings/Code".

### 17.9.9 Settings Current sensor

These menu bars are displayed if "Current Sensor" is defined in the "Installer/Define Current Sensor" menu.

In the menu, specify the phases (L1, L2 and L3) to which the current sensors have been connected.

In the lower left corner of the screen, "Invalid configuration" will be displayed until L1, L2, and L3 are paired with the three current sensors in the menu.

When activating the "Auto config. current sensors" function, it is important that you have switched off all devices in the house that consume high levels of electricity. Also make sure that the backup thermostat is switched off.

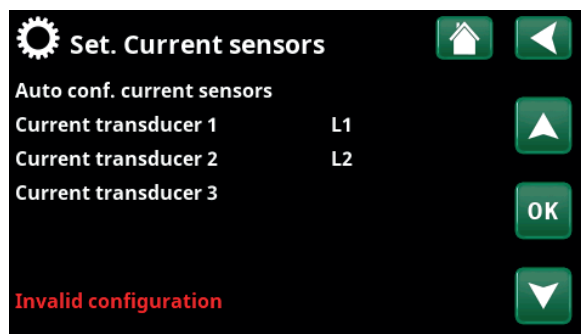

Menu: "Installer/Settings/Current Sensors".

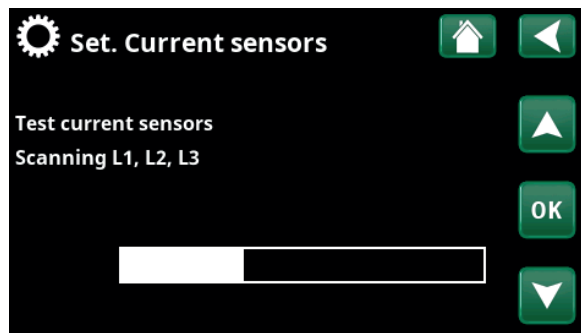

Menu: "Installer/Settings/Current Sensors /Auto config. current sensor".

### 17.9.10 Settings Round circulation schedule

Round circulation is equipment which an electricity supplier can fit in order to disconnect, for a short period of time, equipment which draws high current. The compressor and electrical output are blocked when Round circulation is active.

This menu bar is displayed if a schedule has been defined for the "Round circulation" function.

The "Round circulation" function can also be controlled remotely by activating the "Input" defined for the function.

For more information, refer to:

- chapter "Schedule".
- section "Def. Remote Control" of the "Installer/Define" chapter for defining the remote control function.

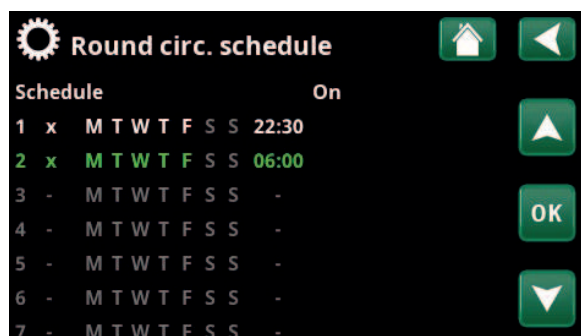

Menu: "Installer/Settings/Round circulation".



### 17.9.11 Settings SmartGrid schedule

This menu is used to schedule the weekday periods during which the "SmartGrid" functions should be active. This schedule is repeated every week.

"SmartGrid" can be used to block a function ("SG Block.") or to achieve a temperature increase during periods when the energy price is low ("SG Low price") or ("SG Overcapacity").

SG Normal mode can be used to easily deviate from any SmartGrid settings for the system on specific days/at specific times.

The "SmartGrid schedule" menu bar is displayed if a schedule has been defined in the "SmartGrid A" row.

For more information, refer to:

- chapter "Schedule".
- chapter "Installer/Define/Remote Control" for defining SmartGrid.

### 17.9.12 Save settings

Custom settings can be saved to "Bank" 1-3 and on a USB drive here. The "USB" row is greyed out until the USB drive is installed. The rows show the date and time of saved settings.

Press "OK" to confirm.

### 17.9.13 Load settings

The saved settings can be recovered.

Press "OK" to confirm.

### 17.9.14 Load Factory settings

The product is supplied with the factory values set. Saved settings in "Bank" 1-3 are deleted when factory settings are restored. The selected language is recovered.

Press "OK" to confirm.



Menu: "Installer/Settings/SmartGrid schedule".

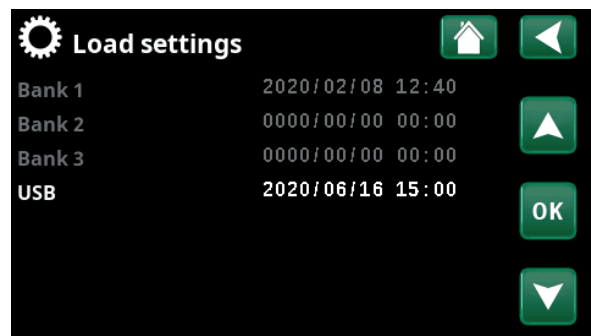

Menu: "Installer/Settings/Load My Settings".



## 17.10 Define

The "Define" menus specify which components and subsystems the system consists of.

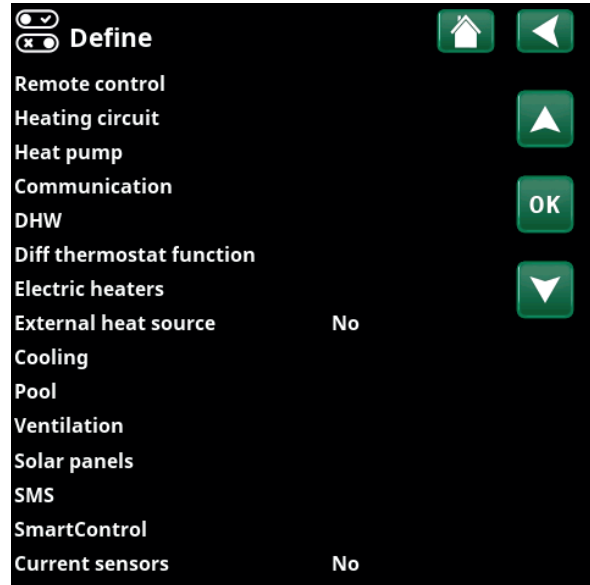

Menu: "Installer/Define".

### 17.10.1 Def. Remote control

This chapter describes all remote control functions; how they are set up and how they are used.

The "Installer/Define/Remote Control" menu defines how the remote control inputs should be activated by specifying one of the following three modes of activation in the "Input" column of this menu:

- a terminal block K22-K23 on the relay card (A2) has power or terminal block K24-K25 is closed. There are two 230 V inputs and two low voltage ports. See table below.
- wireless accessories in the CTC SmartControl series consist of wireless sensors and control units that control signals for temperature, humidity and carbon dioxide level.
- BMS control where control signals are transmitted via the BMS interface.

If you want a function to recur during weekdays, you can set when the function should be active/inactive in a schedule.

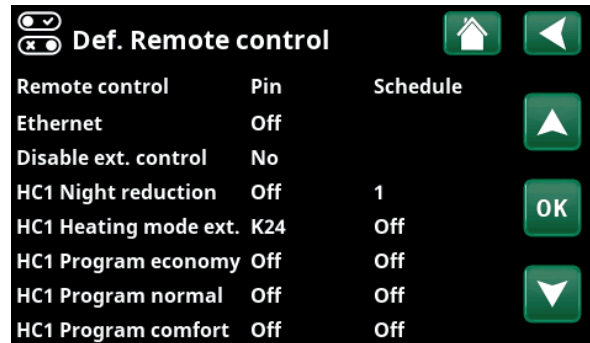

Part of the "Installer / Define/Remote Control" menu.

Designation	Terminal block position	Connection type
K22	A14 & A25	230V
K23	A24 & A25	230V
K24	G33 & G34	Extra-low voltage (<12V)
K25	G73 & G74	Extra-low voltage (<12V)

The table shows the remote control inputs K22-K25 on the relay card.

### 17.10.1.1 Setting the remote control function, example

#### 1. Define an "Input"

First, an input must be assigned to the function or functions to be controlled remotely. This is done in the "Installer/Define/Remote Control" menu.

In the example, terminal block K24 is selected as the input for the "HC1 Heating mode, Ext." function.

#### 2. Configure the function (Normally Open (NO)/Normally Closed (NC))

Define a normal mode for the external control signal; NO or NC. The setting is made for the current heating circuit in the "Installer/Define/Heating Circuit" menu.

For example, a two-way switch can be connected to the defined input.

If the button when used generates a control signal on the input (circuit closes), the circuit shall be defined as NO. When the circuit closes and the control signal is generated, the heating mode selected in the "HC1 Heating mode, ext." row is activated in the settings menu for the heating circuit.

#### 3. Setting the heating mode

In the example, the remote control function "Heating mode, ext." is set to the "Off" position in the "Heating mode, ext." row. This setting is made in the "Installer/Settings/heating circuit" menu.

In this example, the normal heating mode is active ("On").

When input K24 is closed (the multi-button in the example generates a control signal), the status of the Heating Mode (normal mode "On" > mode "Off") changes.

Heating remains off until you choose to start the heating (normal mode "On") by opening terminal block K24 (no signal on the terminal block).

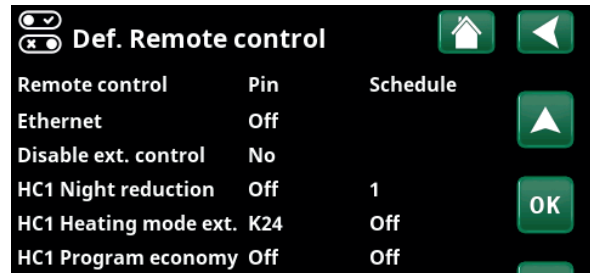

Menu: "Installer/Define/Remote Control".  
Remote control function "HC1 Heating mode, ext." is assigned to terminal block "K24".

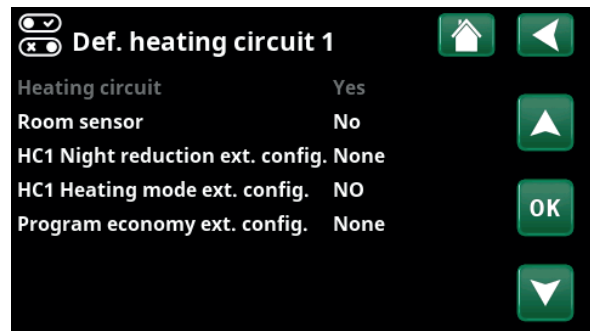

Menu: "Installer/Define/Heating Circuit/ Heating Circuit 1".  
The normal mode of the remote control signal is defined in the "HC1 Heating mode ext. config" row.

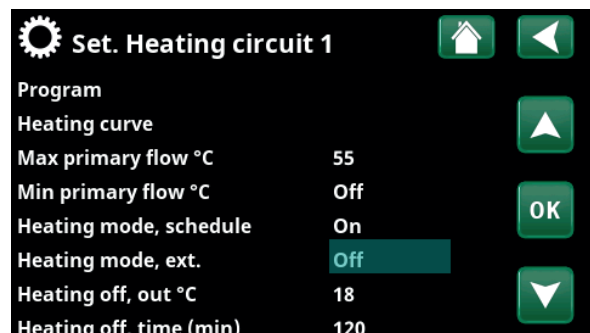

Menu: "Installer/Settings/Heating Circuit/ Heating Circuit 1" Remote control mode "Off" becomes active when terminal block K24 closes.

Open terminal block = Heating mode "On" (in this example).  
Closed terminal block = Heating mode "Off" (in this example).

### 17.10.1.2 Remote control functions

The "Installer/Define/Remote Control" menu defines Inputs for current remote control functions:

- terminal blocks K22, K23, K24, K25.
- wireless accessories in the SmartControl series (Channel 1A, 1B, 2A, 2B, 3A, 3B and so on up to 7B).
- BMS digital input 0-7. Specify a value 0-255. The value must be set again within half an hour for the setting to persist.

#### Ethernet (Modbus TCP/Off)

For information about Modbus TCP Port settings, refer to the "Communication" section in the "Installer/Settings" chapter.

#### Disable ext. control (Yes/No)

Selection "Yes" means disconnecting all external control of the heat pump. Schedule settings are not affected.

#### HC1- Night reduction\* (Off/K22-K25/Channel 1A-7B / BMS DI0-7)

The "Night Reduction" function can be used to, for example, lower the indoor temperature during the night or during working hours.

In the "Installer/Define/Remote Control" menu:

- specify an "Input" for the remote control function.

In the "Installer/Define/Heating Circuit" menu:

- configure the normal mode for the external control signal (Normally Open (NO)/Normally Closed (NC)) in the "HC1 Night reduction ext. config." row.

The schedule can be set in the "Heating/Cooling" menu. For more information, refer to the "Night Reduction Temperature" section in the "Heating/Cooling" chapter.

#### HC1- Heating mode\* (Off/K22-K25/Channel 1A-7B / BMS DI0-7)

Switching between heating season and summer season can take place at a specific outdoor temperature (Auto) or heating can be either always "On" or "Off".

In the "Installer/Define/Remote Control" menu:

- specify an "Input" for the remote control function.

In the "Installer/Define/Heating Circuit" menu:

- configure the normal mode for the external control signal (Normally Open (NO)/Normally Closed (NC)) in the "HC1 Heating mode ext. config." row.

In the "Installer/Settings/Heating Circuit" menu:

- set "Remote Control Mode" ("On", "Off" or "Auto") in the "Heating mode, ext." row.
- Access function scheduling from the "Heating mode, schedule" row.

For more information, refer to the "Heating Circuit" section in the "Installer/Settings" chapter. Also refer to the "Your home's heating settings" chapter.

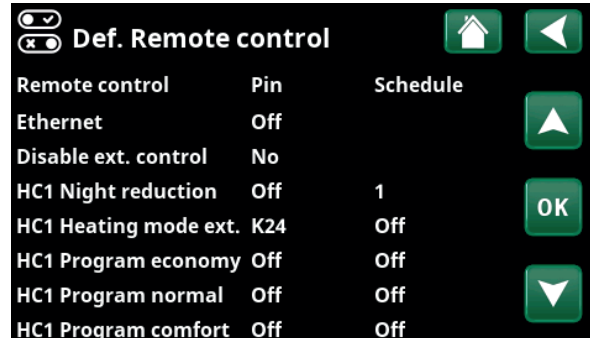

Part of the "Installer/Define/Remote Control" menu. "Input" and "Schedule" are defined here.

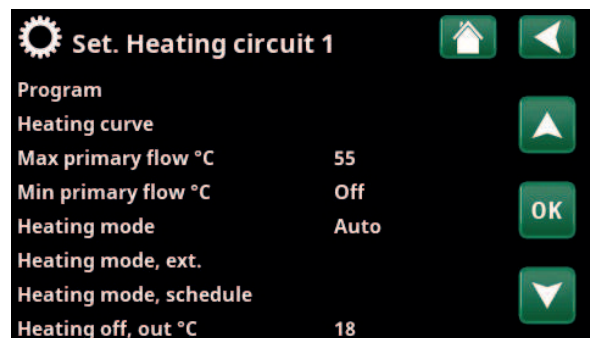

Menu: "Installer/Settings/Heating Circuit". The remote control mode for the heating circuit is set on menu bar "Heating mode, ext.". Access the schedule from the menu bar "Heating mode, schedule".

\*The heat pump can control up to 2 heating circuits.

### HC1- Program economy/normal/comfort/custom ext. config. (Off/K22-K25/Channel 1A-7B/BMS DI0-7)

The program functions "Economy", "Normal" "Comfort" and "Custom" can be used to change the indoor temperature for a certain period.

In the "Installer/Define/Remote Control" menu:

- specify an "Input" for the remote control function.

In the "Installer/Define/Heating circuit":

- configure the normal mode for the external control signal (Normally Open (NO)/Normally Closed (NC))

Setting the schedule is done from the "Heating/Cooling/Program" menu.

For more information, see section "Heating program" in chapter "Heating/Cooling".

### Extra DHW

(Off/K22-K25/Channel 1A-7B/BMS DI0-7)

Upon activation, production of extra DHW begins. When activation stops, extra DHW is produced for a run-on time of 30 min. The "Stop temperature" for extra DHW is set in the "Installer/Settings/DHW/DHW program" menu.

In the "Installer/Define/Remote Control" menu:

- specify an "Input" for the remote control function.

In the "Installer/Define/DHW" menu:

- configure the normal mode for the external control signal (Normally Open (NO)/Normally Closed (NC)) in the "Extra DHW ext. config." row.

Setting extra DHW production to start immediately can also be done in the "DHW" menu. The schedule for extra DHW can also be set in this menu.

For more information, refer to the "Extra DHW" section in the "DHW" chapter.

### Block cooling

(Off/K22-K25/Channel 1A-7B/BMS DI0-7)

In the "Installer/Define/Remote Control" menu:

- specify an "Input" for the remote control function.

In the "Installer/Define/Cooling" menu:

- configure the normal mode for the external control signal (Normally Open (NO)/Normally Closed (NC)) in the "Block cooling ext. config." row.

In the "Installer/Settings/Cooling" menu:

- set "remote control mode" ("Yes") in the "Block cooling ext. config." row.
- Access function scheduling from the "Block cooling schedule" row.

For more information, refer to the "Cooling" section in the "Installer/Settings" chapter.

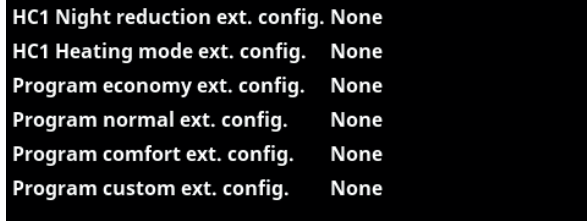

HC1 Night reduction ext. config.	None
HC1 Heating mode ext. config.	None
Program economy ext. config.	None
Program normal ext. config.	None
Program comfort ext. config.	None
Program custom ext. config.	None

Part of the "Installer/Define/Heating circuit menu". In the menu bars "Program economy/normal/comfort/custom ..." the normal mode is indicated on the external control signal ("Normally Open (NO)" or "Normally Closed (NC)").

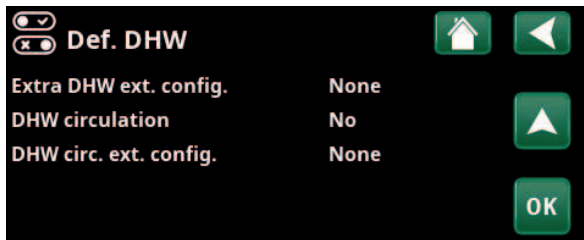

Def. DHW	
Extra DHW ext. config.	None
DHW circulation	No
DHW circ. ext. config.	None

Menu: "Installer/Define/DHW". On menu bar "Extra DHW ext. config.", the normal mode is specified for the external control signal ("Normally Open (NO)" or "Normally Closed (NC)").



DHW	
Extra DHW	Schedule
Off	3.0hours

Setting the "Extra DHW" in the "DHW" menu.

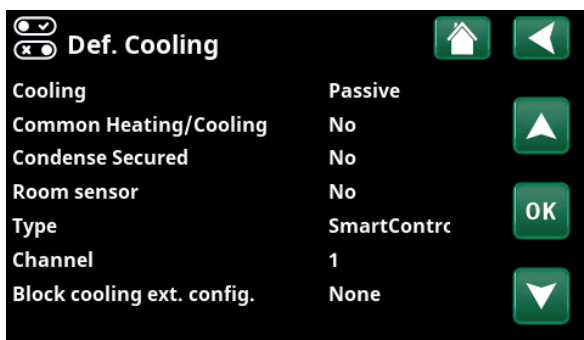

Def. Cooling	
Cooling	Passive
Common Heating/Cooling	No
Condense Secured	No
Room sensor	No
Type	SmartContrc
Channel	1
Block cooling ext. config.	None

On menu bar "Block cooling ext. config.", the normal mode is specified for the external control signal ("Normally Open (NO)" or "Normally Closed (NC)").

## Blocking Pool

(Off/K22-K25/Channel 1A-7B / BMS DI0-7)

This function is used to block pool heating.

In the "Installer/Define/Remote Control" menu:

- specify an "Input" for the remote control function.

In the "Installer/Define/Pool" menu:

- configure the normal mode for the external control signal (Normally Open (NO)/Normally Closed (NC)) in the "Block. pool ext. config." row.

In the "Installer/Settings/Pool" menu:

- set the "remote control mode" ("Yes") in the "Blocking Pool" row.
- Access function scheduling from the "Block. pool, schedule" row.

For more information, refer to the "Pool" section in the "Installer/Settings" chapter.

## Tariff EL

(Off/K22-K25/Channel 1A-7B / BMS DI0-7)

This function is used to block the immersion heater during periods when the electricity rate is higher.

In the "Installer/Define/Remote Control" menu:

- specify an "Input" for the remote control function.

In the "Installer/Settings/Immersion heater" menu:

- set "remote control mode" ("Yes") in the "Tariff EL" row.
- Access function scheduling from the "Tariff EL" row.

For more information, refer to the "Immersion heater/Tariff EL" section in the "Installer/Settings" chapter.

## Round circulation

(Off/K22-K25/Channel 1A-7B / BMS DI0-7)

Round circulation is equipment which an electricity supplier can fit in order to disconnect, for a short period of time, equipment which draws high current. The compressor and electrical output are blocked when Round circulation is active.

In the "Installer/Define/Remote Control" menu:

- specify an "Input" for the remote control function.

In the "Installer/Settings" menu:

- Access function scheduling from the "Round circulation" row.

For more information, refer to the "Round circulation" section in the "Installer/Settings" chapter.

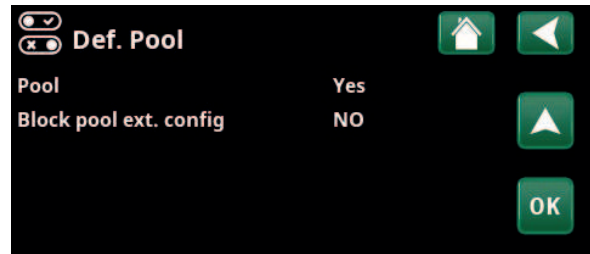

Menu: "Installer/Define/Pool".

Define a mode (Normally Open (NO) or Normally Closed (NC)) for the external control signal.



Part of the "Installer/Settings/Pool" menu.

Activate this function via an external control signal or a schedule.

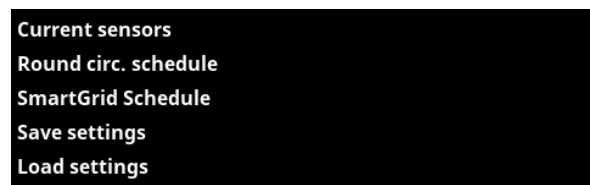

Part of the "Installer/Settings/Settings" menu.

Setting a "Round circulation" schedule.

## DHW circulation

(Off/K22-K25/Channel 1A-7B / BMS DI0-7)

The function allows DHW to circulate in the pipes between the taps and the DHW tank, ensuring that the DHW is hot when the taps are opened.

In the "Installer/Define/Remote Control" menu:

- specify an "Input" for the remote control function.

In the "Installer/Define/DHW" menu:

- configure the normal mode for the external control signal (Normally Open (NO)/Normally Closed (NC)) in the "DHW circulation ext. config." row.

In the "Installer/Settings/DHW" menu:

- Access function scheduling from the "DHW circ. schedule" row.

For more information, refer to the "DHW" section in the "Installer/Settings" chapter.

## Flow/level switch

(Off/K22-K25/Channel 1A-7B / BMS DI0-7)

The flow/level switch produces an alarm on the heat pump.

In the "Installer/Define/Remote Control" menu:

- specify an "Input" for the remote control function.

In the "Installer/Define/Heat Pump" menu:

- configure the normal mode for the external control signal (Normally Open (NO)/Normally Closed (NC)) in the "Flow/level switch" row.

## SmartGrid A / SmartGrid B

(Off/K22-K25/Channel 1A-7B / BMS DI0-7)

In the "Installer/Define/Remote Control" menu:

- specify an "Input" for the remote control function.

There are three SmartGrid functions:

- SmartGrid Low Price
- SmartGrid Overcapacity
- SmartGrid Blocking

Example of "SmartGrid Low Price" for pool heating

In this example, "SmartGrid A" and "SmartGrid B" have been assigned terminal blocks K22 and K23, respectively. In addition, SmartGrid A is assigned "Schedule #1".

According to the settings in the "Set. Pool" menu, the pool setpoint will be increased by 5°C when the electricity price is low (when the "SmartGrid Low price" function is active) and the setpoint will be decreased by 10°C\* when the electricity price is high (when the "SmartGrid Blocking" function is active).

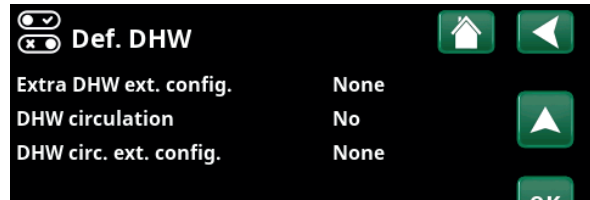

Menu: "Installer/Define/DHW".  
Define a mode (Normally Open (NO) or Normally Closed (NC)) for the external control signal.

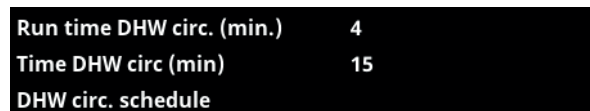

Part of the "Installer/Settings/DHW" menu.  
Setting a "DHW circulation" schedule.



Menu: "Installer/Define/Heat Pump".

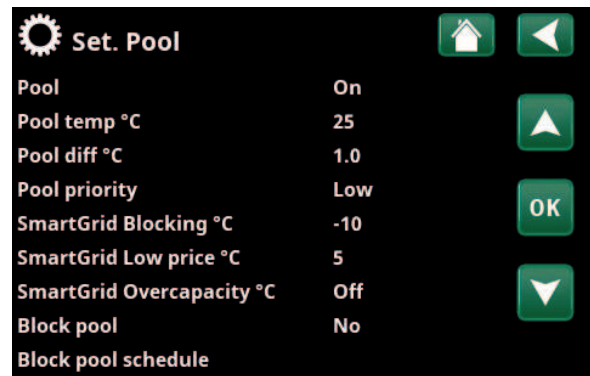

Menu: "Installer/Settings/Pool".  
The pool temperature is increased by 5 °C when the SmartGrid Low Price function is activated.

SmartGrid functions can be set (depending on system configuration/heat pump model) for Heating circuit including Heating program economy/comfort/custom, Heat pumps, Additional heating, Cooling, Pool, DHW tank, Buffer tank and Upper\* and Lower\* tank.

**Heating circuit 1-\***

- SmartGrid Blocking (Off/On)
- SmartGrid Low price °C (Off/1...5 °C)
- SmartGrid Overcapacity °C (Off/1...5 °C)

**Heating program**

**-Comfort:**

- SmartGrid Low price °C (Off/On)
- SmartGrid Overcapacity °C (Off/On)

**-Custom:**

- SmartGrid Low price °C (Off/On)
- SmartGrid Overcapacity °C (Off/On)
- SmartGrid Blocking (Off/On)

**-Economy:**

- SmartGrid Blocking (Off/On)

**Heat pump\***

- SmartGrid Blocking HP (Yes/No)

**Additional Heat/Immersion heater**

- SmartGrid Blocking EL (Yes/No)
- SmartGrid Blocking Mixing valve (Yes/No)

**Cooling**

- SmartGrid Low Price °C (Off/1...5 °C)
- SmartGrid Overcapacity °C (Off/1...5 °C)

**Pool**

- SmartGrid Blocking °C (Off/-1...-50 °C)
- SmartGrid Low Price °C (Off/1...50 °C)
- SmartGrid Overcapacity °C (Off/1...50 °C)

**DHW tank/Lower tank/Upper tank**

- SmartGrid Blocking °C (Off/-1...-50 °C)
- SmartGrid Low Price °C (Off/1...30 °C)
- SmartGrid Overcapacity °C (Off/1...30 °C)

**Buffer tank**

- SmartGrid Low Price °C (Off/1...30 °C)
- SmartGrid Overcapacity °C (Off/1...30 °C)

SmartGrid functions are enabled by activating the SmartGrid inputs in different ways according to the table on the right.

To enable the SmartGrid function "SG Low Price" as shown in the example, terminal block K23 must have power while terminal block K22 should remain unchanged.

The pool temperature increase that will apply when "SG Low Price" is activated is set in the "Pool Settings" menu, as shown in the example.

Alternatively, a schedule can be set up for periodic SmartGrid activation. Refer to the "Schedule" chapter for more information.

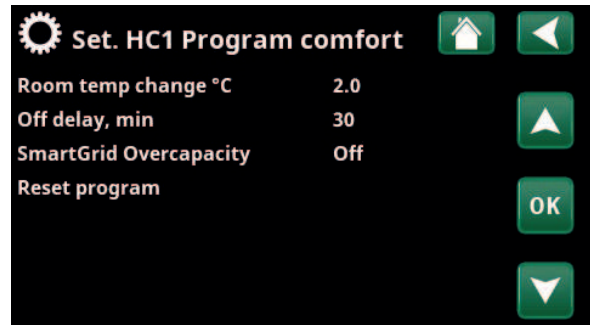

Menu "Installer/Settings/Heating Circuit/Heating Circuit 1/Program/Comfort".

K22 (SG A)	K23 (SG B)	Function
Open	Open	Normal
Open	Closed	Low price
Closed	Closed	Overcapacity
Closed	Open	Blocking

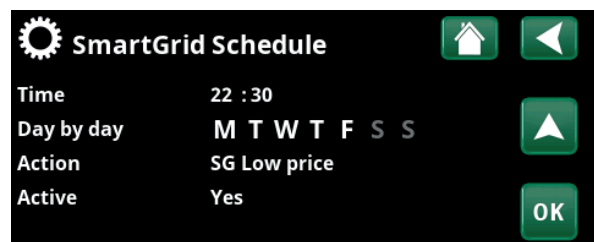

The schedule is set to start at 22:30, weekdays.

\*The heat pump can control up to 2 heating circuits.



### Diff Thermostat function

(Off/K22-K25/Channel 1A-7B/BMS DI0-7)

This function is used to block the diff thermostat function.

In the "Installer/Define/Remote Control" menu:

- specify an "Input" for the remote control function.

In the "Installer/Define/Diff thermostat function" menu:

- configure the normal mode for the external control signal (Normally Open (NO)/Normally Closed (NC)) in the "Blocking diff thermostat ext. config." row.

For more information, refer to the "Diff thermostat function" section in the "Installer/Settings" chapter.

### Tariff HP

(Off/K22-K25/Channel 1A-7B/BMS DI0-7)

This function is used to block the heat pump during periods when the electricity rate is higher.

In the "Installer/Define/Remote Control" menu:

- specify an "Input" for the remote control function.

In the "Installer/Define/Heat Pump" menu:

- configure the normal mode for the external control signal (Normally Open (NO)/Normally Closed (NC)) in the "Tariff HP ext. config." row.

In the "Installer/Settings/Heat Pump" menu:

- set "Tariff HP" ("On").

For more information, refer to the "Heating Pump" section in the "Installer/Settings" chapter.

### HP Noise reduction

(Off/K22-K25/Channel 1A-7B/BMS DI0-7)

Applies only to modulating heat pump CTC GSi 600.

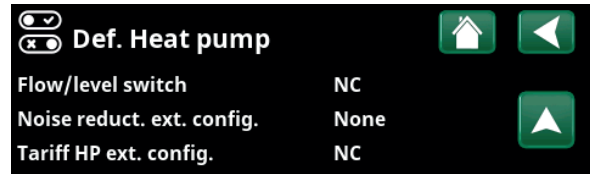

Menu: "Installer/Define/Heat Pump".

A mode for the external control signal ("Normally Open (NO)" or "Normally Closed (NC)") is defined for "Tariff HP ext. config."

## 17.10.2 Def. Heating Circuit

**Heating Circuit 1** Yes (Yes/No)

Heating Circuit 1 (HC 1) is predefined by the control system. Heating Circuit 2 is shown on the row underneath if connected.

**Room sensor** Yes (Yes/No/Show)

Selection "Yes" means that room sensors should be connected to the heating circuit.

If "Show" is selected, the room temperature is displayed but the room sensor is not used for control.

**Type** Wireless (Cable/Wireless/SmartControl)

Select whether the room sensor for the heating circuit has a wired (via cable) or wireless connection.

- **Wireless**  
Select "Wireless" to connect CTC's wireless room sensors to the heating circuit. Refer to the "CTC Wireless Room Sensor" manual for information on how to connect these sensors.
- **SmartControl**  
SmartControl is a separate series of wireless accessories. If "SmartControl" is selected, the connection channel must be selected in the row below. SmartControl accessories are connected to the system via the "Installer/Define/SmartControl" menu. Refer to the separate SmartControl Accessories manual.

**HC1- Night reduction ext. config.** None (None/NO/NC)

This menu defines the Normally Open (NO) or Normally Closed (NC) mode for the external control signal when remotely controlling the function.

For examples of how to set the normal mode, refer to the "Installer/Define/Remote Control" chapter.

**HC1- Heating mode ext. config.** None (None/NO/NC)

This menu defines the Normally Open (NO) or Normally Closed (NC) mode for the external control signal when remotely controlling the function.

For examples of how to set the normal mode, refer to the "Installer/Define/Remote Control" chapter.

**Program \* ext. config.** None (None/NO/NC)  
**\*economy/normal/comfort/custom**

This menu defines the Normally Open (NO) or Normally Closed (NC) mode for the external control signal when remotely controlling the function.

For examples of how to set the normal mode, refer to the "Installer/Define/Remote Control" chapter.

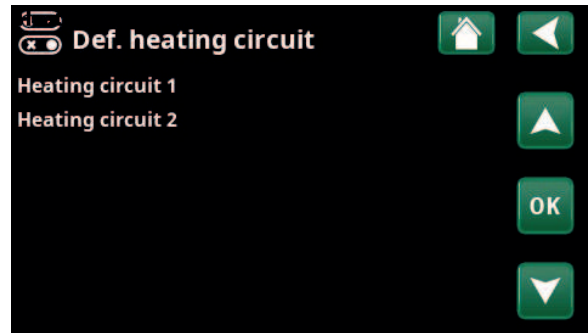

Menu: "Installer/Define/Heating Circuit".  
Select a heating circuit and press "OK" to access the settings.

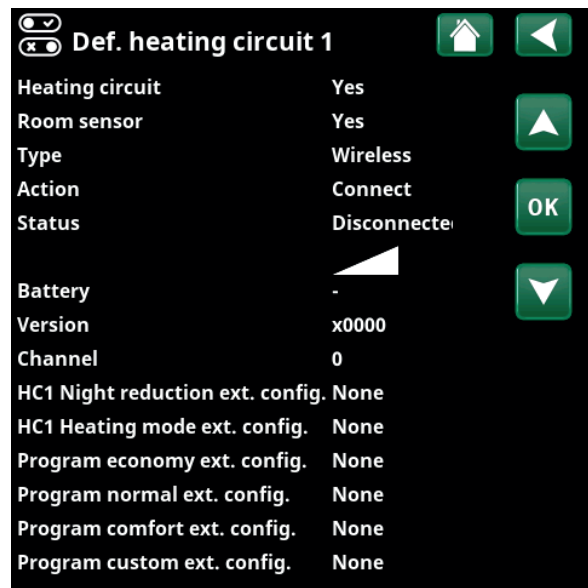

Menu: "Installer/Define/Heating Circuit/ Heating Circuit 1".  
Wireless room sensor selected.

### 17.10.3 Def. Heat pump

**Flow/level switch** **NC (None/NC/NO)**

This menu bar is displayed if an "Input" for remote control is defined for the "Flow/level switch" function in the "Installer/Define/Define Remote Control" menu.

**Noise reduct. ext. config.** **None (None/NC/NO)**

Applies only to modulating heat pump CTC GSi 600.

**Tariff HP ext. config.** **NC (None/NC/NO)**

This menu bar is displayed if an "Input" for remote control is defined for the "HP Tariff" function in the "Installer/Define/Remote Control" menu.

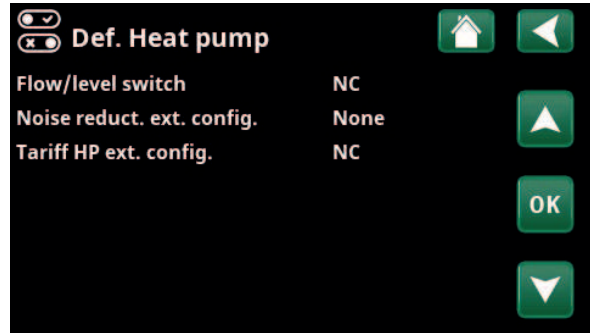

Menu: "Installer/Define/Heat Pump".

### 17.10.4 Def. Communication

**myUplink** **No (Yes/No)**

Select "Yes" to connect to the heat pump from the myUplink app.

**Web** **No (Yes/No)**

Select "Yes" to connect to the local web server. Internet router and firewall required.

**El.prices** **myUplink/myUplink ext./BMS/No**

Select "myUplink" to connect the heat pump to the myUplink mobile app for electricity price control.

Select "myUplink ext." to connect via myUplink to an external price control app. This option is not available at the moment.

Select "BMS" to connect via property management.



Menu: "Installer/Define/Communication".



For more information, see the "Installation Communication" chapter of this manual.

### 17.10.5 Def. DHW

**Extra DHW ext. config.** **None (None/NC/NO)**

This menu defines the Normally Open (NO) or Normally Closed (NC) mode for the external control signal when remotely controlling the function.

For examples of normal mode settings, refer to the "Def. Remote Control" section of the "Installer/Define" chapter.

**DHW circulation** **No (Yes/No/DHW)**

"Yes" DHW circulation (DHW circ.) with circulation pump G40 must be defined. This functionality option requires the Expansion Card (A3) accessory in order for DHW circulation to be monitored by the product.

"DHW" Alternative with external DHW circ. pump which is not controlled by the product. Does not require expansion card (A3).

**DHW circ. ext. config.** **None (None/NC/NO)**

This menu defines the Normally Open (NO) or Normally Closed (NC) mode for the external control signal when remotely controlling the function.

For examples of normal mode settings, refer to the "Def. Remote Control" section of the "Installer/Define" chapter.

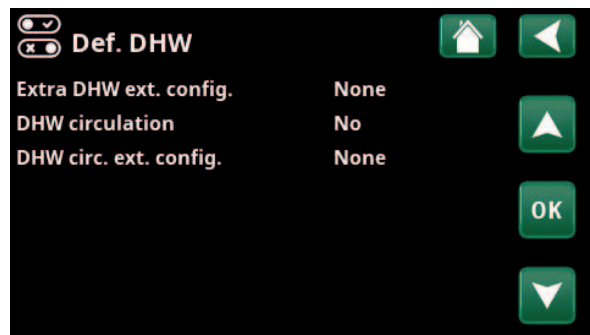

Menu: "Installer/Define/DHW".

### 17.10.6 Def. Diff thermostat function

**Diff thermostat function** **No (No/Yes)**

Specify here whether the diff thermostat function is to be used in the system.

The expansion card accessory (A3) needs to be installed for this function.

**Blocking diff thermostat ext. config.** **None (None/NC/NO)**

This menu defines the Normally Open (NO) or Normally Closed (NC) mode for the external control signal when controlling the function remotely.

For examples of normal mode settings, refer to the "Def. Remote Control" section of the "Installer/Define" chapter.

Information about the Differential thermostat function is shown in chapter "Operation info".

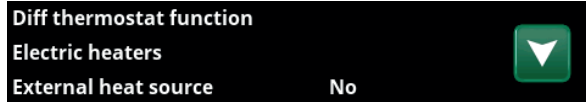

Menu: "Installer/Define/Diff thermostat function".

### 17.10.7 Def. Immersion heater

**Tariff EL ext. config.** **None (NO/NC/None)**

The function can block the immersion heater at times of high electricity tariffs by means of an external signal.

This menu defines the Normally Open (NO) or Normally Closed (NC) mode for the external control signal when remotely controlling the function.

For examples of normal mode settings, refer to the "Def. Remote Control" section of the "Installer/Define" chapter.

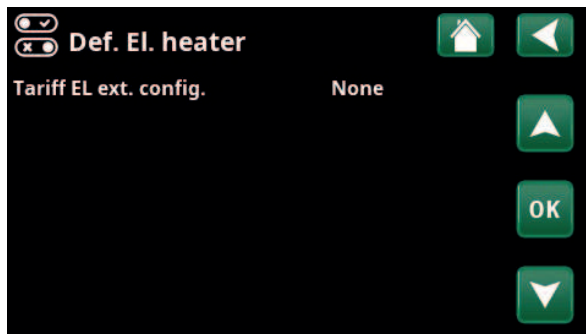

Menu: "Installer/Define/Immersion heater".

### 17.10.8 Def. External heat source (EHS)

**External heat source** **No (Yes/No)**

Specify here whether an external heat source is connected to the heating circuit.

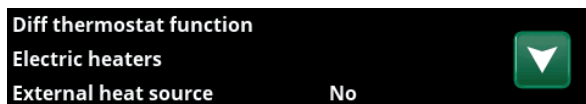

Menu: "Installer/Define/External heat source (EHS)".

### 17.10.9 Def. Cooling

Cooling is adjusted using primary flow sensor 2 (B2), which then means that heating circuit 2 and cooling cannot be used simultaneously.

**Cooling** **No (Yes/No)**

Select "Yes" to connect cooling if the circulation pump (G3), mixing valve Y3, primary flow sensor (B3) and room sensor (B13) are connected to the system.

**Common Heating/Cooling** **No (Yes/No)**

"Yes" means that cooling and heating are distributed in the same heating circuit.

**Condense secured** **No (No/Yes)**

If the system is condensation-proofed, significantly lower temperatures are permitted at various points in the system. **WARNING!** Build-up of condensation in the house structure can lead to damp and damage from mildew.

"No" means a setting range for room temperature of 18-30 °C and "Yes" means a setting range of 10-30 °C.

In the event of doubt, contact a professional for an assessment.

**Room sensor** **Yes (Yes/No/Show)**

Selection "Yes" means that room sensors should be connected to the heating circuit.

If "Show" is selected, the room temperature is displayed but the room sensor is not used for control.

**Type** **Cable//SmartControl**

Select whether the heating circuit room sensor is:

- **Cable**  
Wired room sensor.
- **SmartControl**  
SmartControl is a separate series of wireless accessories. If "SmartControl" is selected, the connection channel must be selected in the row below. These accessories must be connected to the heating circuit via the "Installer/Define/SmartControl" menu. Refer to the separate "Installation and Maintenance Manual" for the SmartControl accessory.

**Block cooling ext. config.** **None (None/NC/NO)**

This menu bar is displayed if an "Input" for remote control is defined for the "Block Cooling" function in the "Installer/Define/Remote Control" menu.

The function can be used to turn off cooling with the help of a humidity sensor when there is a risk of condensation.

This menu defines the Normally Open (NO) or Normally Closed (NC) mode for the external control signal when remotely controlling the function.

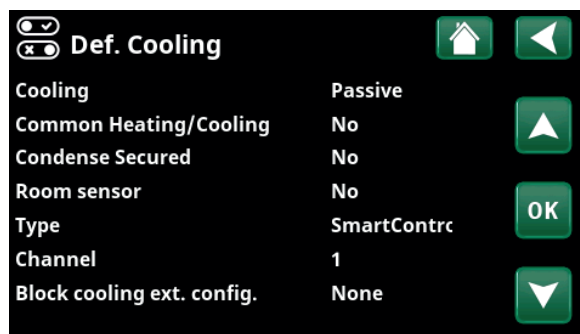

Menu: "Installer/Define/Cooling".

**!** A room sensor must always be used in that part of the property which is to be cooled, as it is the room sensor which determines/controls cooling capacity.

### 17.10.10 Def. SMS

**Activate** **No (Yes/No)**

If "Yes" is selected, the menus below are displayed:

#### Level of signal

The signal strength of the reception is shown here.

#### Phone Number 1

The first activated phone number is shown here.

#### Phone Number 2

The second activated phone number is shown here.

#### Hardware Version

The hardware version of the SMS accessory is shown here.

#### Software Version

The software version of the SMS accessory is shown here.

**NB:** For more information about the SMS function, refer to the "Installation and Maintenance Manual" for CTC SMS.

### 17.10.11 Def. SmartControl

SmartControl is a separate series of wireless accessories.

**SmartControl** **No (Yes/No)**

If "Yes" is selected, SmartControl accessories can be connected to the heating circuit. Refer to the connection procedure in the separate SmartControl Accessories manual.

### 17.10.12 Def. Current sensor

**Current sensor** **Yes (Yes/No)**

Select "Yes" if current sensors are to be connected to the system.

For more information, refer to the "Current Sensors" section in the "Installer/Settings" chapter.

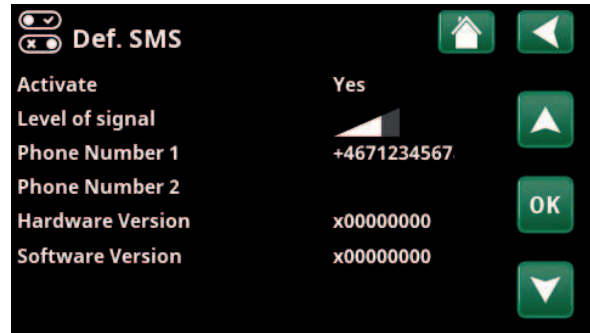

Menu: "Installer/Define/ SMS".

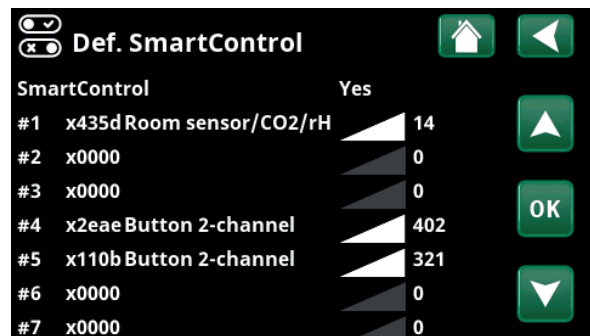

Menu: "Installer/Define/SmartControl".



## 17.11 Service



NB: This menu is intended for the installer only.

### 17.11.1 Function test

From this menu, the installer can test the connection and function of separate components of the heating circuit. When this menu is activated, all control functions are stopped. The only protection against incorrect operation is the pressure sensors and the immersion heater's overheating protection device. The heat pump returns to normal operation after 10 minutes of inactivity or when exiting the "Function Test" menu. When the menu is opened, all automatic functions are stopped and testing can be performed.



When you exit the menu, the heat pump returns to normal operation.

#### 17.11.1.1 Test Heating circuit

**Mixing valve 2** Close (Close/Open)

Opens and closes Mixing Valve 2.

**Heating circ pump 2** Off (On/Off)

Starts and stops Radiator Pump 2.

**LED room sensor** Off (On/Off)

The room sensor alarm functions can be controlled from here. When activated, the respective room sensor's red LED comes on steady.

#### 17.11.1.2 Test Heat pump

**HP Compressor** Off (On/Off)

When the compressor is being function tested, the brine and charge pump are also operating so that the compressor does not trigger its pressure switches.

**HP Brine pump/Fan** Off (Off/On)

Function test brine pump or fan (air-to-water heat pump).

**HP Charge pump** Off (Off/On/ 0...100)

Function test charge pump 0-100%.

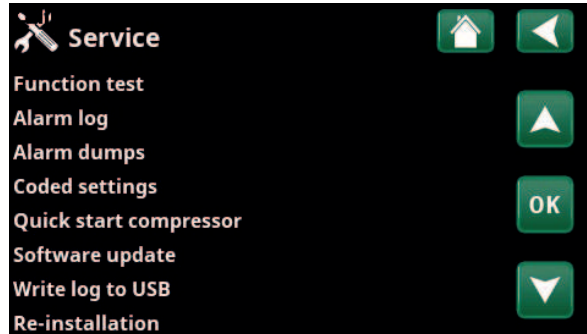

Menu: "Installer/Service".

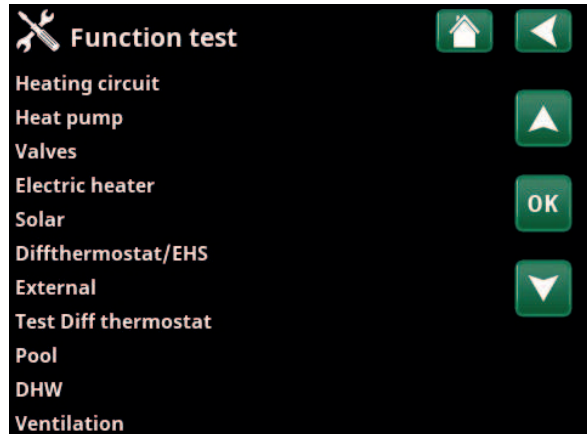

Menu: "Installer/Service/ Function Test".

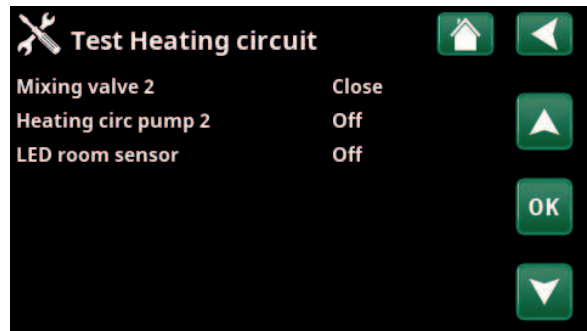

Menu: "Installer/Service/ Function Test/Heating Circuit".

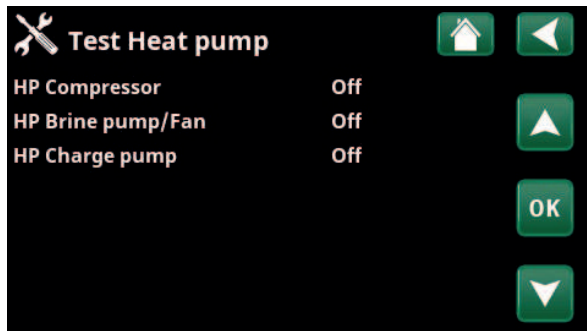

Menu: "Installer/Service/ Function Test/Heat Pump".

### 17.11.1.3 Test Valves

**3-way valve** **HS (HS/DHW)**

Function test carried out on the flow conditioner (Y21).  
Test of flow to hot water or to the heating circuit.

- HC = Heating Circuit
- DHW = Domestic Hot Water



Menu: "Installer/Service/ Function Test/Valves".

### 17.11.1.4 Test Immersion heater

Tests the immersion heater per phase and step (On/Off).

<b>Immersion heater L1A</b>	<b>Off (Off/On)</b>
<b>Immersion heater L1B</b>	<b>Off (Off/On)</b>
<b>Immersion heater L2A</b>	<b>Off (Off/On)</b>
<b>Immersion heater L2B</b>	<b>Off (Off/On)</b>
<b>Immersion heater L3A</b>	<b>Off (Off/On)</b>
<b>Immersion heater L3B</b>	<b>Off (Off/On)</b>
<b>Immersion heater A13</b>	<b>Off (Off/On)</b>

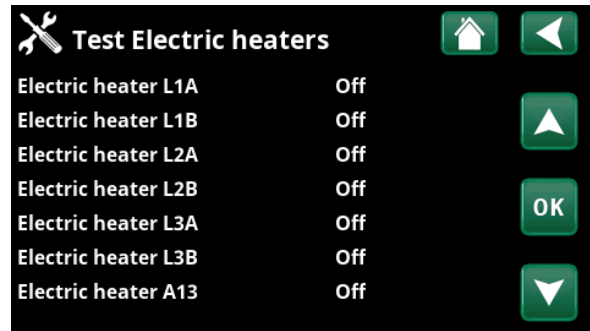

Menu: "Installer/Service/ Function Test/Immersion heater".

### 17.11.1.5 External

**Pump (G46)** **Off (On/Off)**

Function test of circulation pump to tank transfer.

**Mixing valve (Y41)** **Close (Close/Open)**

Function test of mixing valve for the external heat source tank.

#### Temperatures

This displays current temperatures.

- **EHS-tank °C (B47)** **67 °C**
- **Diff thermostat °C (B46)** **68 °C**

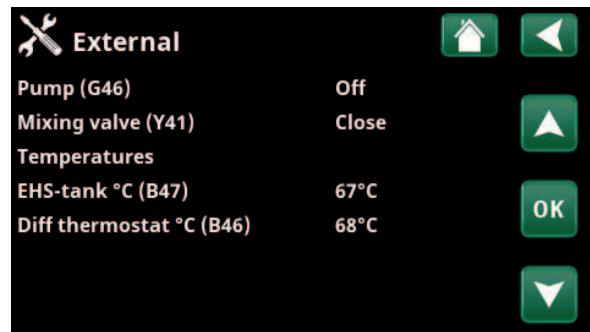

Menu: "Installer/Service/ Function Test/Diff Thermostat".

### 17.11.1.6 Test DHW

**Tap water pump (G5)** **0 (-0...100)**

Function test of the tap water pump for hot water.

**DHW circulation pump (G40)** **Off (On/Off)**

Test of hot water circulation pump.

#### Sensor

- **DHW °C (B25)** **0 °C**

Displays current DHW temperature.

• **Flow sensor (B102)** **Off (On/Off)**

Indicates whether there is flow in the DHW pipe.

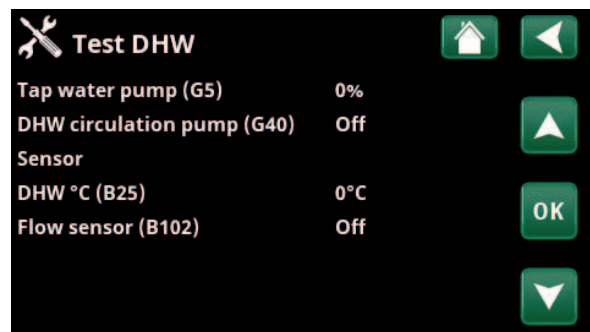

Menu: "Installer/Service/ Function Test/DHW".



### 17.11.2 Alarm log

In the alarm log, up to 500 alarms can be displayed at the same time.

An alarm which reoccurs within an hour is ignored so as not to fill up the log.

Click an alarm row to see more information about an alarm.

If it is a "sensor alarm", a sensor value will be displayed at the bottom of the page from when the alarm was triggered for further troubleshooting.

For alarms related to the heat pump, values can be displayed from sensors for pressure (HP, LP), temperature (SH=Superheating) and current (I).

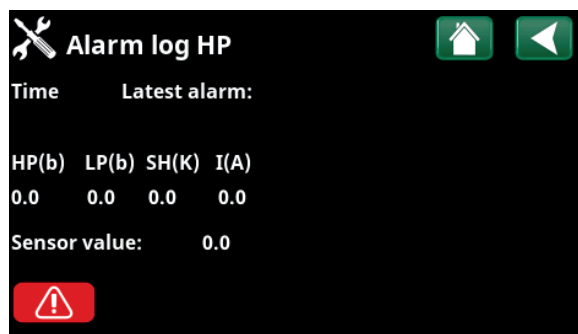

Menu: "Installer/Service/Alarm logs".

### 17.11.3 Alarm dumps

Export the alarms displayed in the alarm log to a USB drive. A dump can consist of one or more alarms as well as specific values before and after the alarm was triggered.

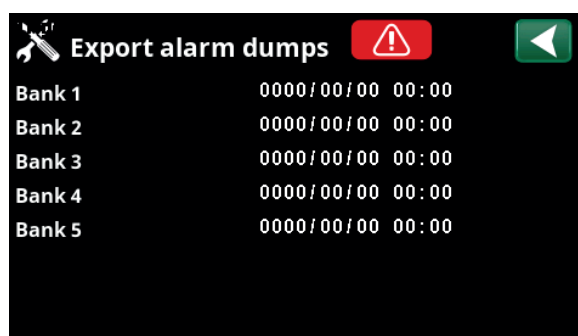

Menu: "Installer/Service/Alarm Dumps".

### 17.11.4 Settings coded

This menu is intended to set the manufacturer's operational and alarm limits. A 4-digit code must be specified to be able to amend these limits. However, you can also look without any code to see what options feature in the menu.

### 17.11.5 Quick start compressor

The delay normally prevents compressor start earlier than 10 mins after compressor stop. The delay is also activated in the event of a power failure, or the first time after production is started. This function speeds up this process.

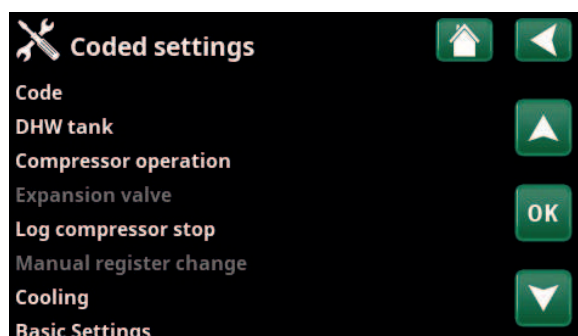

Menu: "Installer/Service/Coded settings".

### 17.11.6 Software update

The display software can be updated either via USB drive or online. The rows are greyed out until the USB drive is installed or the display is connected to the internet.

Click OK to confirm the upload.

The settings are retained during updating, but the old values are overwritten by any new factory values.

### 17.11.7 Write log to USB

Intended for service engineers. This function can be used to save logged values to a USB memory stick.

### 17.11.8 Re-installation

This command relaunches the installation sequence. First, confirm that you want to reinstall to access the installation wizard, refer to the "Installation Guide" and "First Start" chapters.

### 17.11.9 Control current sensors

This is for identifying which current sensor is connected to the relevant phase.

All three currents (L1, L2 and L3) will appear in the current operation data when the heat pump has identified the current transformers' relevant phases.

**In this situation it is important that you have switched off any major consumers of electricity in the house. Also make sure that the backup thermostat is turned off.**

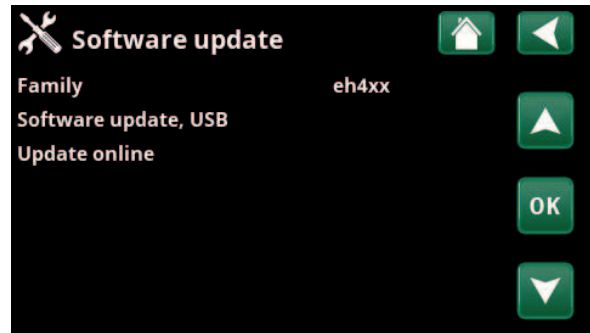

Menu: "Installer/Service/ Software Update".

**!** NB: The power to the product must not be interrupted, under any circumstances, during the update process.

**!** NB: Turn off the power and always restart the product after software update. Several minutes may pass before the display communicates clearly after restart.

**!** NB: Only an authorised service engineer is allowed to log in to the Factory settings coded option. Severe operational problems and faults may occur affecting the product if values are amended without authorisation. Note that in such cases the warranty terms do not apply.

## 18. Troubleshooting

The heat pump is designed to provide reliable operation and high levels of comfort, and to have a long service life. Various tips are given below which may be helpful and guide you in the event of an operational malfunction.

If a fault occurs, you should always contact the installer who installed your unit. If the installer believes the malfunction is due to a materials or design fault, then they will contact us to check and rectify the issue. Always provide the product's serial number.

### DHW

Many people want to gain maximum benefit from the heat pump's low operating costs.

The control system is equipped with three comfort levels for DHW. We recommend starting at the lowest level and if there is not enough hot water, increase it to the next level. We also recommend that you operate a regular DHW pattern.

Check that the DHW temperature is not being affected by a poor mixing valve, whether at the heat pump or possibly the shower mixer.

### The heating system

The room sensor ensures that the temperature in the room is always suitable and stable. For the sensor to provide the correct signals to the control unit, radiator thermostats should always be fully open in the area where the room sensor is located.

A correctly operating heating circuit is important to the heat pump's operation and affects energy savings.

When adjusting the system, always do so with all radiator thermostats fully open. The thermostats can be individually adjusted after a few days in the other rooms.

#### If you do not achieve the set room temperature, check:

- That the heating circuit is correctly adjusted and is functioning normally. That radiator thermostats are open and the radiators are equally warm all over. Touch the entire radiator surface. Bleed the radiators. For the heat pump to run economically, the heating circuit must function well in order to provide good savings.
- That the heat pump is operating and no error messages are displayed.
- That there is sufficient electrical power available. Increase if necessary. Also check that the electric power output is not limited due to excessively high electricity loads in the property (load monitor).
- That the product is not set to the "Max. permitted primary flow temperature" mode with a too low value.
- That "Primary flow temperature at -15 °C outdoor temperature" is set sufficiently high. Increase if necessary. More can be read about this in the section entitled "The property's heating curve". However, always check the other points first.
- That the temperature reduction is set correctly. See Settings/Heating circuit.

#### If heating is uneven, perform a check (if room sensor installed):

- That the placement of the room sensors is appropriate for the house.
- That the radiator thermostats don't interfere with the room sensor.
- That no other heat sources/cold sources interfere with the room sensor.

● Avoid running DHW at the highest flow capacity. If you run a bath at a rather slower rate instead, you will get a higher temperature.

● Avoid placing the room sensor close to the stairway due to the uneven air circulation.

● If you do not have radiator thermostats on the upper floor, you may need to install them.

## Current monitor

The heat pump has an integrated current monitor. If the system is fitted with a current sensor, the property's main fuses are continuously monitored to ensure they are not overloaded. If this should happen, electric stages are disconnected from the heat pump. The heat pump may be restricted where high heating requirement levels are combined with, for example, single-phase engine heaters, cookers, washing machines or tumble dryers. This may result in inadequate heating or DHW temperatures. If the heat pump is limited, "High current, elpower redu (X A)" appears in text form in the display. Consult an electrician to determine whether the fuse size is correct or the three phases in the house are evenly loaded.

## Ground loop

Faults can occur in the cooling unit if the ground loop has not been installed correctly, if it has not been bled sufficiently, if it contains too little antifreeze or is not designed to an adequate size. Poor or insufficient circulation can result in the heat pump triggering an alarm in the case of low evaporation. If the temperature difference between the ingoing and outgoing temperature is too large, the product triggers an alarm and "Low brine flow" is displayed. The probable cause is that there is still air in the brine circuit. Bleed thoroughly, which may in some cases take up to a day. Also check the ground loop. See also the section entitled "Connecting the brine system". Reset the "Low evaporation" alarm on the display. Where a malfunction repeatedly occurs, call in a technician to investigate and rectify the fault.

If the text "Low brine temp" is displayed, the ground loop may not be large enough or there may be a fault with the sensor. Check the brine circuit temperature in the "Current operation data" menu. If the incoming temperature falls below -5 °C during operation, call in a technician to inspect the brine circuit.

## Air problems

If you hear a rasping sound from the heat pump, check that it is properly bled. Top up with water where required, so that the correct pressure is achieved. If this noise recurs, call a technician to check the cause.

### Unusual noise when shutting off DHW

In some cases, unusual noises may be produced by the cold water, pipe work and heat pump due to the jolts which occur when the flow is quickly interrupted. There is no fault with the product, but the noise may occur when older types of instant closing mixers are used. More recent types are often fitted with a soft-closing mechanism. If an unusual sound comes from hard-closing dishwasher and washing machines, this can be remedied using a shock arrestor. A shock arrestor can also be an alternative to soft-closing water taps.

 Don't forget that the radiators may also need bleeding.

## 18.1 Information messages

Information messages are displayed when appropriate and are intended to inform users about various operational situations.

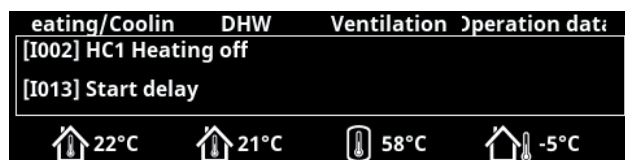

### [I002] HC1 Heating off

### [I005] HC2 Heating off

Shows for each heating circuit that the product is operating in summer mode when only DHW is required, not heating.

### [I008] Tariff HP off

Indicates that Tariff has switched off the heat pump.

### [I009] Compressor blocked

The compressor is set to be shut down, e.g. before drilling or digging has been carried out for the collector coils. The product comes with the compressor switched off. This option is selected in the "Installer/Settings/Heat Pump" menu.

### [I010] Tariff EL Off

Shows that tariff has switched off the immersion heater elements.

### [I011] Round circulation

Indicates that round circulation is active. Round circulation is a device which an electricity supplier can fit with the aim of disconnecting high current draw equipment for a short period of time. The compressor and electrical output are blocked when round circulation is active.

### [I012] High curr., reduced elec.

- The property's main fuses risk being overloaded due to, for example, the simultaneous use of several power-hungry appliances. The product reduces the immersion heater's electrical output during this period.
- 2h max. 6 kW. Electric heating elements are limited to 6 kW for 2 hours after being switched on. This message appears if more than 6 kW are required during the product's first 2 hours of operation. This is applicable after a power outage or a new installation.

### [I013] Start delay

The compressor is not allowed to start too quickly when it has stopped. The delay is usually at least 10 minutes.

### [I014] Drying period active, d

Indicates that the floor function is active and displays the time (days) remaining that the function will be active.

### [I017] SmartGrid: Block

### [I019] SmartGrid: Low price

### [I018] SmartGrid: Overcapacity

The product is externally affected by "SmartGrid". See also "Define/Remote control/SmartGrid".

### [I021] Ext. Ctrl Heating 1

### [I022] Ext. Ctrl Heating 2

The remote control affects whether the heating is to be on or off. If the heating is switched off, "Heating off, heating circuit 1/2" is also displayed.

### [I028] Holiday period

Displayed when setting the holiday schedule, which entails lowering the room temperature and that no hot water is produced.

## 18.2 Alarm messages

Heating/Cooling	DHW	Ventilation	Operation data
	Alarm: [E074] Room sensor 1		Mis
	[E006] Brine pump		Mis
Reset alarm			Mis
			Mis

If a fault occurs with e.g. a sensor, an alarm is triggered. A message appears on the display with information about the fault.

You reset the alarm by pressing the Reset Alarm button on the display. If several alarms are triggered, they are displayed one after the other. A persisting fault must first be rectified before it can be reset. Some alarms are reset automatically if the fault ceases.

Alarm messages	Description
<b>[E010] Compressor type ?</b>	This message appears if no information about the compressor type is available.
<b>[E013] EVO off</b>	This message appears when there is a fault with the expansion valve control.
<b>[E024] Fuse blown</b>	This message appears when the fuse (F1, F2) has been triggered.
<b>[E026] Heat pump</b>	This message appears if the heat pump is in alarm mode.
<b>[E027] Communication error HP</b>	This message is displayed when the display card (A1) cannot communicate with the HP control card (A5).
<b>[E063] Comm. err. relay board</b>	This message is displayed when the display card (A1) cannot communicate with the relay card (A2).
<b>[E056] Comm. err. motor protection</b>	This message is displayed when the HP control card (A5) cannot communicate with the motor protection (A4).
<b>[E086] Comm. err. expansion card</b>	This message is displayed when the display card (A1) cannot communicate with CTC Solar control/Expansion card (A3).
<b>[E035] High pressure switch</b>	The refrigerant's high pressure switch has been triggered. Press reset and check whether the alarm recurs. If the fault recurs, contact your installer.
<b>[E040] Low brine flow</b>	Low brine flow is often caused by air in the collector system, especially immediately following installation. Collectors which are too long can also be a cause. Press reset and check whether the alarm recurs. Also check the brine filter that has been installed. If the fault recurs, contact your installer.
<b>[E041] Low brine temp.</b>	Incoming brine temperatures from bore hole/ground loop are too low. Press reset and check whether the alarm recurs. If the fault recurs, contact your installer to check the dimensions of the cold side.
<b>[E044] Stop, high compr temp.</b>	This message appears when the compressor temperature is high. Press reset and check whether the alarm recurs. If the fault recurs, contact your installer.
<b>[E045] Stop, low evaporation</b>	This message appears when the evaporation temperature is low. Press reset and check whether the alarm recurs. If the fault recurs, contact your installer.
<b>[E046] Stop, high evaporation</b>	This message appears when the evaporation temperature is high. Press reset and check whether the alarm recurs. If the fault recurs, contact your installer.
<b>[E047] Stop, low suct. gas exp. valve</b>	This message appears when the suction gas temperature is low. Press reset and check whether the alarm recurs. If the fault recurs, contact your installer.
<b>[E048] Stop, low evapor.</b>	This message appears when the expansion valve's evaporation temperature is low. Press reset and check whether the alarm recurs. If the fault recurs, contact your installer.

<b>Alarm messages</b>	<b>Description</b>
<b>[E049] Stop, high evapor exp.v.</b>	This message appears when the expansion valve's evaporation temperature is high. Press reset and check whether the alarm recurs. If the fault recurs, contact your installer.
<b>[E050] Stop, low superheat exp.v</b>	This message appears when the expansion valve's overheat temperature is low. Press reset and check whether the alarm recurs. If the fault recurs, contact your installer.
<b>[E052] Phase 1 missing [E053] Phase 2 missing [E054] Phase 3 missing</b>	This message appears in the event of a phase failure.
<b>[E055] Wrong phase order</b>	The product's compressor motor must rotate in the right direction. The product checks that the phases are connected correctly; otherwise, an alarm is triggered. This will require changing two of the phases into the product. The power supply to the system must be shut off when rectifying this fault. This fault generally only occurs during installation.
<b>[Exxx] Alarm 'sensor'</b>	An alarm message is displayed if an error occurs with a sensor that is not connected or has short-circuited and if the value is outside the sensor's range. If this sensor is important to the system's operation, the compressor stops. This requires the alarm to be reset manually after the fault has been rectified. The alarm is reset automatically after correction for the following sensors: Sensor upper tank (B5), Sensor EHS tank (B47), Sensor primary flow 1 (B18), Sensor primary flow 2 (B2), Sensor out (B15), Room sensor 1 (B11), Room sensor 2 (B12), Sensor brine out, Sensor brine in, Sensor HPin, Sensor HPout, Sensor discharge, Sensor suction gas, Sensor high pressure, Sensor low pressure.
<b>[E057] Motor protect high curr.</b>	High current into the compressor has been detected. Press reset and check whether the alarm recurs. If the fault recurs, contact your installer.
<b>[E058] Motor protect low curr.</b>	Low current into the compressor has been detected. Press reset and check whether the alarm recurs. If the fault recurs, contact your installer.
<b>[E061] Max. Thermostat</b>	This alarm message appears if the product becomes too hot.  During installation, make sure the max. thermostat (F10) has not been triggered as there is a chance of this occurring if the boiler has been stored in extremely cold temperatures, Reset it by pressing in the button on the electrical switchboard behind the front panel.











[www.ctc.se](http://www.ctc.se), [www.ctc-heating.com](http://www.ctc-heating.com)  
+46 372 88 000  
Fax: +46 372 86 155  
P.O Box 309 SE-341 26 Ljungby Sweden



**MADE IN SWEDEN**